



▶ User Guide for the Polycom®
SoundPoint IP® 670 Phone

Trademark Information

POLYCOM®, the Polycom “Triangles” logo and the names and marks associated with Polycom’s products are trademarks and/or service marks of Polycom, Inc. and are registered and/or common law marks in the United States and various other countries. All other trademarks are property of their respective owners. No portion hereof may be reproduced or transmitted in any form or by any means, for any purpose other than the recipient’s personal use, without the express written permission of Polycom.

Patent Information

The accompanying product is protected by one or more U.S. and foreign patents and/or pending patent applications held by Polycom, Inc.

Disclaimer

Some countries, states, or provinces do not allow the exclusion or limitation of implied warranties or the limitation of incidental or consequential damages for certain products supplied to consumers, or the limitation of liability for personal injury, so the above limitations and exclusions may be limited in their application to you. When the implied warranties are not allowed to be excluded in their entirety, they will be limited to the duration of the applicable written warranty. This warranty gives you specific legal rights which may vary depending on local law.

Copyright Notice

Portions of the software contained in this product are:

Copyright © 1998, 1999, 2000 Thai Open Source Software Center Ltd. and Clark Cooper

Copyright © 1998 by the Massachusetts Institute of Technology

Copyright © 1998-2003 The OpenSSL Project

Copyright © 1995-1998 Eric Young (eay@cryptsoft.com). All rights reserved

Copyright © 1995-2002 Jean-Loup Gailly and Mark Adler

Copyright © 1996-2004, Daniel Stenberg, <daniel@haxx.se>

Permission is hereby granted, free of charge, to any person obtaining a copy of this software and associated documentation files (the “Software”), to deal in the Software without restriction, including without limitation the rights to use, copy, modify, merge, publish, distribute, sublicense, and/or sell copies of the Software, and to permit persons to whom the Software is furnished to do so, subject to the following conditions:

The above copyright notice and this permission notice shall be included in all copies or substantial portions of the Software.

THE SOFTWARE IS PROVIDED “AS IS”, WITHOUT WARRANTY OF ANY KIND, EXPRESS OR IMPLIED, INCLUDING BUT NOT LIMITED TO THE WARRANTIES OF MERCHANTABILITY, FITNESS FOR A PARTICULAR PURPOSE AND NONINFRINGEMENT. IN NO EVENT SHALL THE AUTHORS OR COPYRIGHT HOLDERS BE LIABLE FOR ANY CLAIM, DAMAGES OR OTHER LIABILITY, WHETHER IN AN ACTION OF CONTRACT, TORT OR OTHERWISE, ARISING FROM, OUT OF OR IN CONNECTION WITH THE SOFTWARE OR THE USE OR OTHER DEALINGS IN THE SOFTWARE.

© 2009 Polycom, Inc. All rights reserved.

Polycom, Inc.

4750 Willow Road

Pleasanton, CA 94588-2708

USA

No part of this document may be reproduced or transmitted in any form or by any means, electronic or mechanical, for any purpose, without the express written permission of Polycom, Inc. Under the law, reproducing includes translating into another language or format.

As between the parties, Polycom, Inc., retains title to and ownership of all proprietary rights with respect to the software contained within its products. The software is protected by United States copyright laws and international treaty provision. Therefore, you must treat the software like any other copyrighted material (e.g., a book or sound recording).

Every effort has been made to ensure that the information in this manual is accurate. Polycom, Inc., is not responsible for printing or clerical errors. Information in this document is subject to change without notice.

About This Guide

Thank you for choosing the SoundPoint IP 670 , a full-duplex, hands-free SIP desktop phone. This unit provides business telephony features and functions such as multiple call appearances, call hold, transfer, and conference over an IP network.

This guide provides everything you need to quickly use your new phone. Be sure to verify with your system administrator that your network is prepared for configuring your SoundPoint IP 670 phone. As well, be sure to read the [Parts List](#) and [Regulatory Notices](#) sections in this guide before you set up and use the SoundPoint IP 670 phone. You can also find this information at <http://www.polycom.com/support/voicedocumentation/>.

Changes to This Guide

The following sections are new for this edition:

- [Information Status](#) on page 1-14
- [Changing the Soft Key Label Color](#) on page 2-10

Major updates have occurred to the following sections since the previous edition:

- [Changing the Graphic Display Background](#) on page 2-9
- [Searching the Corporate Directory](#) on page 2-19
- [Enabling Do Not Disturb](#) on page 3-21
- [Recording a Call](#) on page 4-8
- [Playing Back a Recorded Call](#) on page 4-13

Contents

About This Guide	iii
Changes to This Guide	-iii
1 Getting Started with Your Phone	1-1
Parts List	1-2
Assembling Your Phone	1-3
Connecting Network and Power Source	1-3
Connecting the Handset and Optional Headset	1-5
Attaching the Base	1-6
Registering Your Phone	1-9
Features of Your Phone	1-9
Before You Use Your Phone	1-14
Using the Navigation Keys	1-14
Information Status	1-14
Using a USB Device to Record Calls	1-15
Cleaning the LCD Glass	1-16
2 Customizing Your Phone	2-1
Configuring Basic Settings	2-2
Changing the Appearance of Time and Date	2-2
Changing the Display Contrast	2-3
Changing the Backlight Intensity	2-4
Enabling the Headset Memory Mode	2-6
Selecting the Correct Headset for Electronic Hookswitch	2-7
Selecting the Ring Type	2-7
Changing the Language	2-8
Changing the Graphic Display Background	2-9
Changing the Soft Key Label Color	2-10
Muting the Microphone	2-11
Adjusting the Volume	2-12
Managing Call Lists	2-12

Managing Contacts	2-13
Adding Contacts	2-13
Editing Contacts	2-16
Deleting Contacts	2-17
Placing Calls to Contacts	2-18
Searching for Contacts	2-18
Managing Incoming Calls	2-21
Distinguishing Calls	2-21
Rejecting Calls	2-22
Diverting Calls	2-23
System Customizations	2-24
Supporting Multiple Lines	2-24
Supporting Multiple Line Keys Per Line	2-25
Supporting Shared Lines	2-25

3 Using the Basic Features of Your Phone 3-1

Placing Calls	3-2
Answering Calls	3-4
Ending Calls	3-7
Redialing Numbers	3-8
Placing Calls on Hold	3-8
Hosting Conference Calls	3-9
Setting Up Conference Calls	3-10
Managing Conferencing Calls	3-12
Adding Parties to Conference Calls	3-14
Joining Conferences	3-16
Splitting Conference Calls	3-16
Ending Conferencing Calls	3-16
Transferring Calls	3-17
Forwarding Calls	3-19
Enabling Do Not Disturb	3-21
Assigning Speed Dial Keys	3-23
Using Voice Mail	3-25

4 Using the Advanced Features of Your Phone 4-1

Using Multiple Call Appearances	4-1
Using Text Messaging	4-3
Using Buddy Lists	4-5
Presence Settings	4-5
Managing Buddies	4-6

Integrating With Microsoft Live Communications Server 2005 4-7

Recording a Call 4-8

 Recording Calls 4-10

 Recording Conferences 4-11

 Pausing and Resuming Recording 4-12

Playing Back a Recorded Call 4-13

 Browsing Recorded Calls 4-14

 Playing Back Recorded Calls 4-14

 Answering a Call While Playing Back Recorded Calls 4-16

Restarting Your Phone 4-17

5 Using the SoundPoint IP Color Expansion Module 5-1

Parts List 5-2

Connecting the SoundPoint IP Color Expansion Module 5-3

Features of the SoundPoint IP Color Expansion Module 5-4

Adjusting the Display Contrast 5-5

Adjusting the Backlight 5-5

Placing Calls 5-5

Answering Calls 5-6

Assigning Speed Dial Keys 5-6

Using the Busy Lamp Field 5-8

6 Troubleshooting Your Phone 6-1

Power and Startup 6-2

Controls 6-3

Access to Screens and Systems 6-4

Calling 6-5

Displays 6-7

Audio 6-8

Productivity Suite 6-8

Testing Phone Hardware 6-9

Regulatory Notices Safety Notices-1

Index Index-1

End-User License Agreement for Polycom® Software

Getting Started with Your Phone

This chapter provides basic installation instructions and information for obtaining the best performance with the SoundPoint IP 670 desktop phone.

The SoundPoint IP 670 provides a powerful, yet flexible IP communications solution, delivering excellent voice quality. The high-resolution colorgraphic display supplies content for call information, multiple languages, directory access, and system status. The SoundPoint IP 670 supports advanced functionality, including multiple call and flexible line appearances, HTTPS secure provisioning, presence, custom ring tones, local conferencing, applications, and Polycom® HD™ Voice technology.

The SoundPoint IP 670 provides a visually improved platform for applications which can leverage its color display.

Powered by state of the art Gigabit Ethernet IP telephony technology, the SoundPoint IP 670 features a future-proof dual-port Gigabit Ethernet switch for seamless integration with a computer or desktop server. For organizations with existing GigE deployment, the SoundPoint IP 670 delivers unobstructed, high-speed access to data and productivity-boosting data and applications. For organizations with plans to migrate to GigE, the SoundPoint IP 670 protects investment in desktop networking.

When equipped with up to three SoundPoint IP Color Expansion Modules, the SoundPoint IP 670 turns into a productivity-enhancing attendant console for attendants to increase call handling capability and to view presence information without the need for a computer.

This chapter contains:

- [Parts List](#)
- [Assembling Your Phone](#)
- [Registering Your Phone](#)
- [Features of Your Phone](#)
- [Before You Use Your Phone](#)

To customize your phone, refer to [Customizing Your Phone](#) on page 2-1. To read about the phone's basic features, refer to [Using the Basic Features of Your Phone](#) on page 3-1. To read the phone's advanced features, refer to [Using the](#)

[Advanced Features of Your Phone](#) on page 4-1. To add a SoundPoint IP Color Expansion Module to your SoundPoint IP 670 phone, refer to [Using the SoundPoint IP Color Expansion Module](#) on page 5-1.

If you require additional information or assistance with your new phone, contact your system administrator.

Parts List

The following components are included in your SoundPoint IP 670 phone package:

- Polycom SoundPoint IP 670 phone

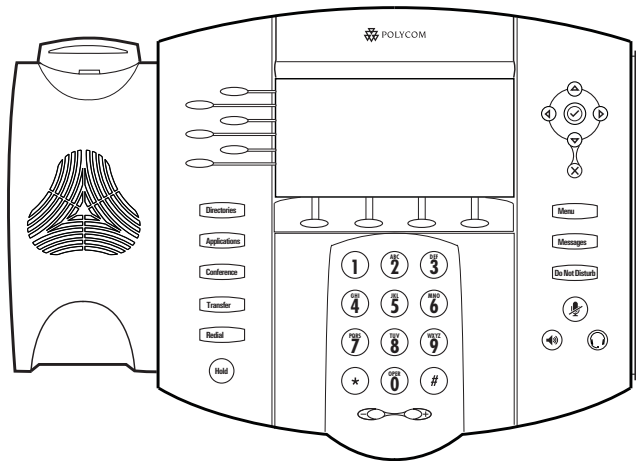

- handset and handset cord

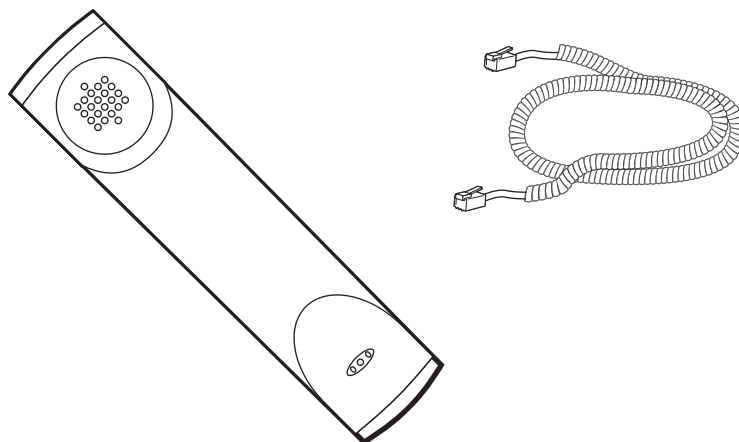

- Phone Base
- Network / Power Cable

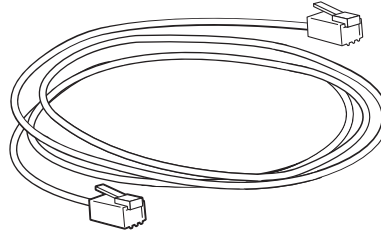

- Quick Start Guide and registration card

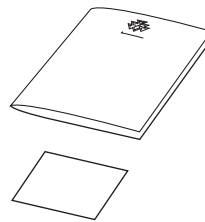

Check this list before installation to ensure that you have received each item. If you are missing any items, contact your system administrator.

Assembling Your Phone

This section describes how to assemble your SoundPoint IP 670 phone. These topics include:

- [Connecting Network and Power Source](#)
- [Connecting the Handset and Optional Headset](#)
- [Attaching the Base](#)

If your phone is already assembled, go directly to [Features of Your Phone](#) on page 1-9.

Connecting Network and Power Source

You have two options for network and power source connections. Your system administrator will advise you on which one to use.

You can use one of the following methods:

- AC power
- Power over Ethernet (PoE)

AC Power

To connect the AC power:

1. Connect the supplied network cable between the LAN jack on the phone and the LAN port on the wall or hub/switch device.
2. Connect the DC plug on the power adapter to the DC 48V jack marked on the phone.
3. Connect the country-specific AC cord to the power adapter.

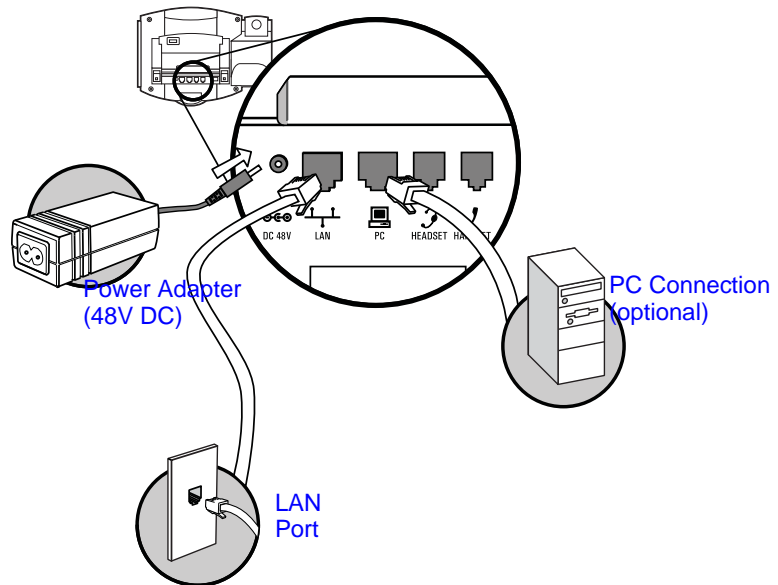

Power over Ethernet

Using a regular CAT5 cable (optional accessory from Polycom), the phone can be powered from a PoE (IEEE 802.3af) compliant switch or hub.

To connect the PoE:

- Plug the supplied network cable between the LAN jack on the phone and an available power and data port on the in-line power switch.

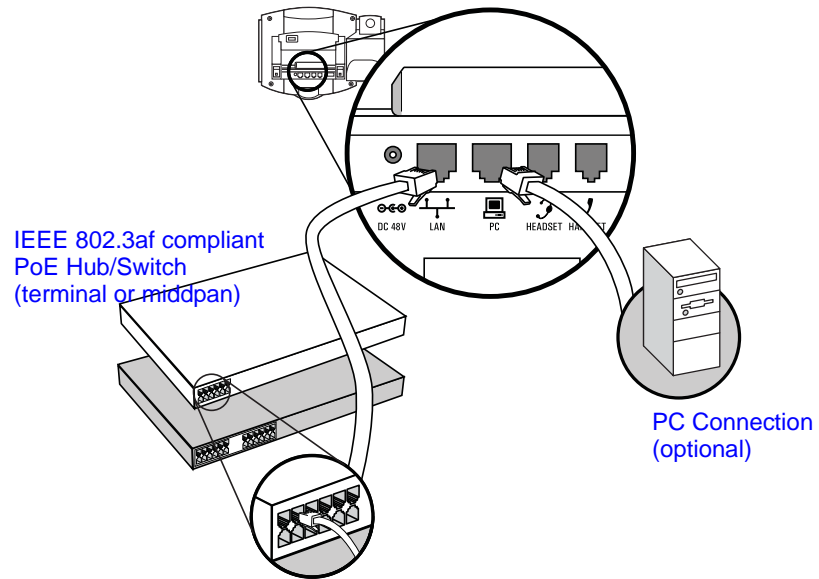

Connecting the Handset and Optional Headset

To connect the handset and optional headset:

1. Connect the short straight end of the phone cord to the handset and the corresponding longer straight end of the cord to the handset jack on the back of the phone.

2. Connect the headset (optional) to the headset jack on the back of the phone.

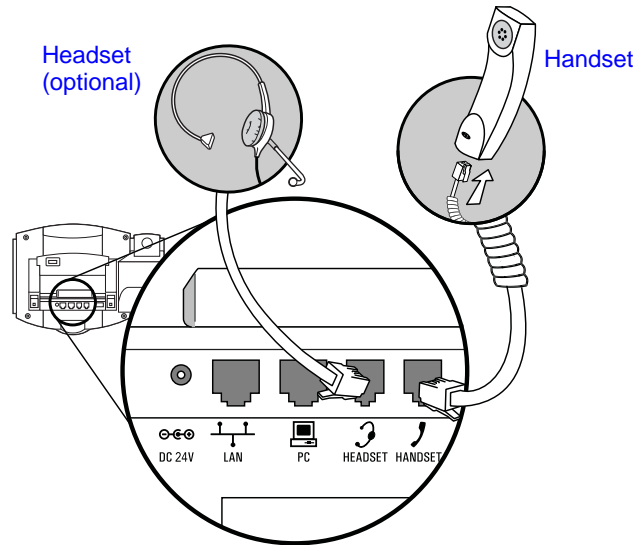

For information on supported headsets, go to http://www.polycom.com/support/voice/soundpoint_ip/VoIP_Technical_Bulletins_public.html and look for "Technical Bulletin 37477: Headset Compatibility List".

Attaching the Base

You can attach the base to the SoundPoint IP 670 phone in one of two ways:

- As a desk mount
- As a wall mount

Note

The wall mount is not included in SoundPoint IP 670 package. Contact your system administrator if you require one.

To attach the base as a desk mount:

1. Place all cords in the recessed area above the modular jacks.

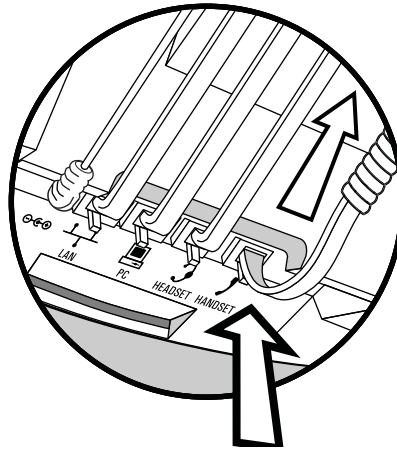

2. Align the two protrusions on the bracket with their corresponding holes in the phone.

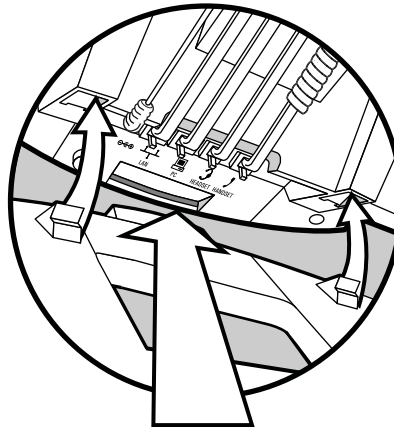

3. Snap them together to lock the base to the phone.

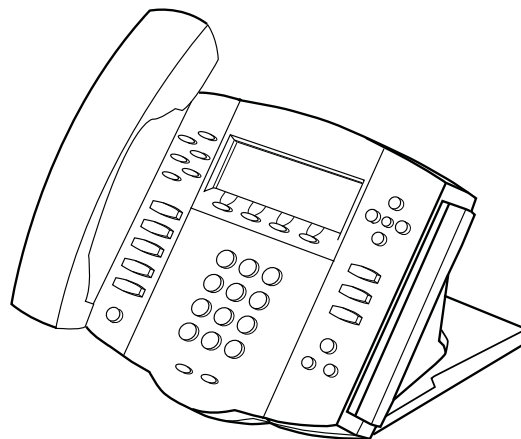

To attach the base as a wall mount:

1. Place all cords in the recessed area above the modular jacks.

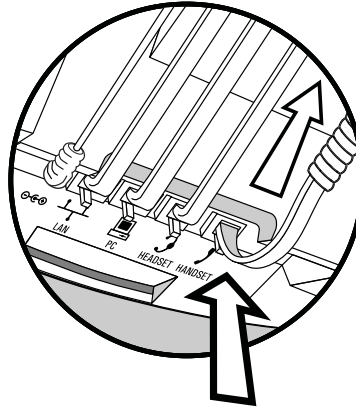

2. On the back of the phone, remove the key located behind the hookswitch and reposition it so that the end tab (at a 45° angle) is facing up.

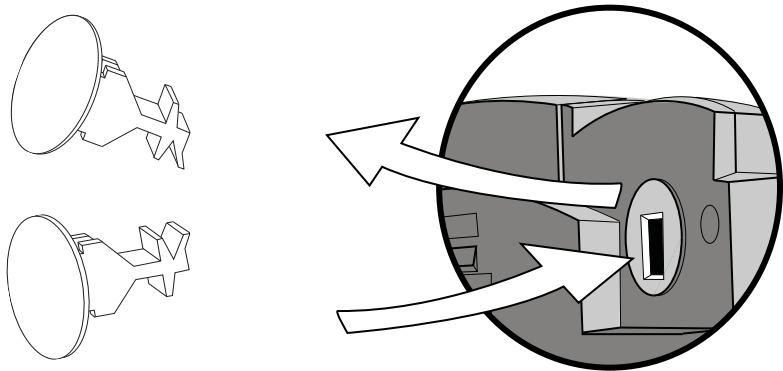

3. With mounting tab of the base unit facing up, fasten the base unit to the wall mount using wall anchors (not included).

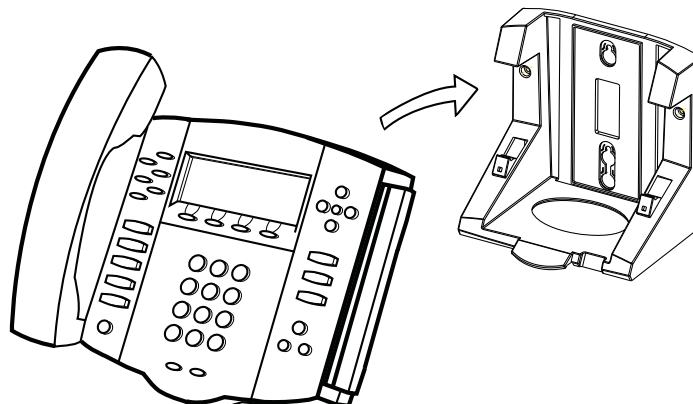

Note

The wall mount is not included in SoundPoint IP 670 package. Contact your system administrator if you require one.

Registering Your Phone







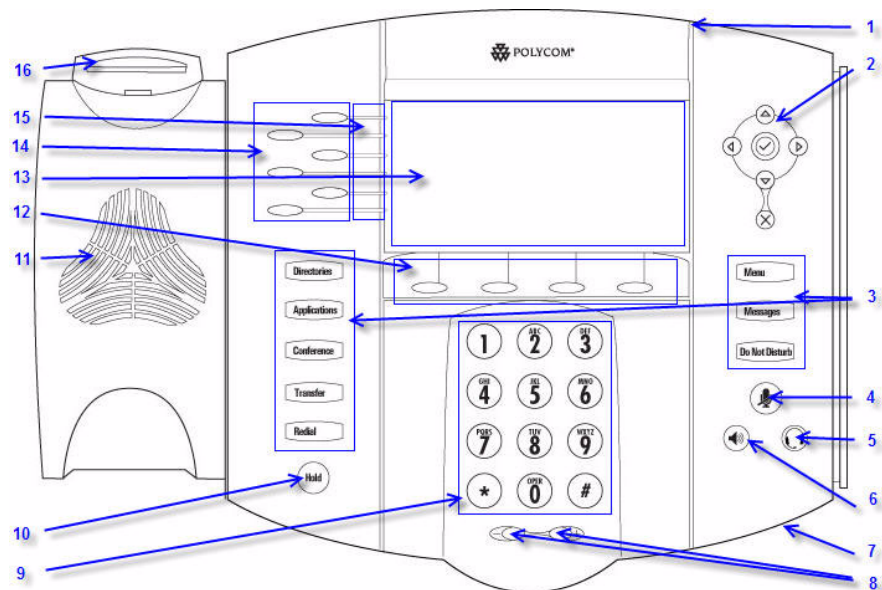









Generally, your phone will be deployed with multiple other phones. In this case, your system administrator will configure the phone parameters beforehand, so that after you set up your phone, the phone will be registered and ready to use.



If your phone is not part of a large phone deployment, your phone may not be registered after you set it up. Before you use your phone, you or your system administrator will have to register it. For detailed information on how to register your phone after you install it, refer to “Quick Tip 44011: Registering Standalone SoundPoint IP, SoundStation IP, and Polycom VVX Phones” at http://www.polycom.com/usa/en/support/voice/soundpoint_ip/VoIP_Technical_Bulletins_pub.html.

Features of Your Phone













The features of your SoundPoint IP 670 phone are:

	Item	Description
1	Message Waiting Indicator	Alert for voice and text (instant) messages.
2	Arrow Keys	
	 	Scroll through displayed information.
	 	
		Select a field of displayed data.
		Delete displayed data.
3	Feature Keys	Access important features using these keys.
		Access to local directories and call lists.
		Access to special applications (contact system administrator).
		Allows connection with multiple other parties for a conference.
		Transfer of current call to third party.
		Dials most recently dialed party.
		Access local (your phone) and global (your organization) features.
		Access and manage text and voice messages.
		Cancels ringing and directs incoming calls to your voice mail (if supported).
4	Microphone Mute 	Mutes audio transmission locally during calls and conferences.
5	Headset 	Allows you to place and receive calls through an optionally connected headset.

	Item	Description
6	Speakerphone 	Allows for hands-free communication during calls.
7	Hands-free Microphone	Picks up audio during hands-free calls. Place your phone on a hard, flat surface for best results.
8	Volume Keys 	Adjusts the volume of the handset, headset, speaker, and ringer.
9	Dial Pad	Provides the 10 digits, the alphabetic characters, and special characters available in context-sensitive applications.
10	Hold 	Holds an active call or resumes a held call.
11	Speaker	For ringer and hands-free audio output.
12	Soft Keys	These keys are automatically labeled to identify their context-sensitive functions.
13	Graphic Display	Shows information about calls, messages, soft keys, time, date, and other relevant data. <ul style="list-style-type: none"> • Caller display information—first party, second party, number of calls • Information status line <ul style="list-style-type: none"> • Popup text (for example, network errors) • Do Not Disturb text • Missed call text or second incoming caller display • Prompt text (for example, “Enter number”) • Time and date text (if idle display is not used for time/date display) <p>Associated line icons are described in the following table.</p>

	Item	Description
14	Line/Speed Dial Key 	Use these keys to activate up to six lines or speed dials that can be assigned to your phone.
15	Line Indicators	Individual multi-color LEDs display the dynamic call state and remote user status (busy lamp field (BLF) and presence). The mapping is: <ul style="list-style-type: none"> • Solid green—An active call is in progress. • Fast flashing green—There is an incoming (ringing) call. • Flashing green—The call is held by the other party. • Flashing red—The call is on hold. • Solid red—The line is busy remotely (shared lines)
16	Hookswitch	

Icons associated with the line keys appear on the graphic display and represent:

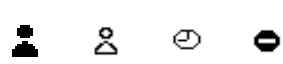
Icon	Description
	Registered line (solid)
	Registered shared line
	Unregistered line (outline)
	Voice mail/Text messages
	Speed dial
	Ringing
	Call in progress with HD Voice
	Call in progress
	Call Forward
	Do Not Disturb
	Conference
	Presence/Busy Lamp Field (BLF)









Before You Use Your Phone

Note

The background and key colors that appear on your SoundPoint IP 670 phone may differ from what appears in this user guide. For more information, refer to [Changing the Graphic Display Background](#) on page 2-9.

Using the Navigation Keys

To help you navigate menus and enter data, use these tips:

- To scroll through lists, use  and  or hold down  and .
- Press the * key to page up. Press the # key to page down. Use these shortcuts when lists appear on more than one page.
- To move one level down and one level up when menus have submenus, use  and .
- To exit from any menu, press .
- To exit from any directory, press .
- Use the dial pad keys to navigate through and make selections in numbered menu lists.
- To enter text using the dial pad, press the number keys one or more times. For example, for 'A' press 2 and for 'C' press 222. When in text entry mode, the title will show whether keys will generate digits (1), upper-case (A), or lower-case (a) characters— use the **1/A/a** soft key to change— and whether keys will generate ASCII, Latin, Cyrillic, Katakana, or Unicode characters— use the **Encoding** soft key to change.

Information Status

The top line of the screen (or graphic display) shows status information. It appears as a scrolling list if there is more than one message. The number of messages in the list also appears. In order of precedence from highest to lowest, the messages are:

- Popup text (for example, network errors)
- Do Not Disturb text
- Missed call text or second incoming caller display

- Prompt text (for example, “Enter number”)
- Time and date text

The following figures provide some examples:

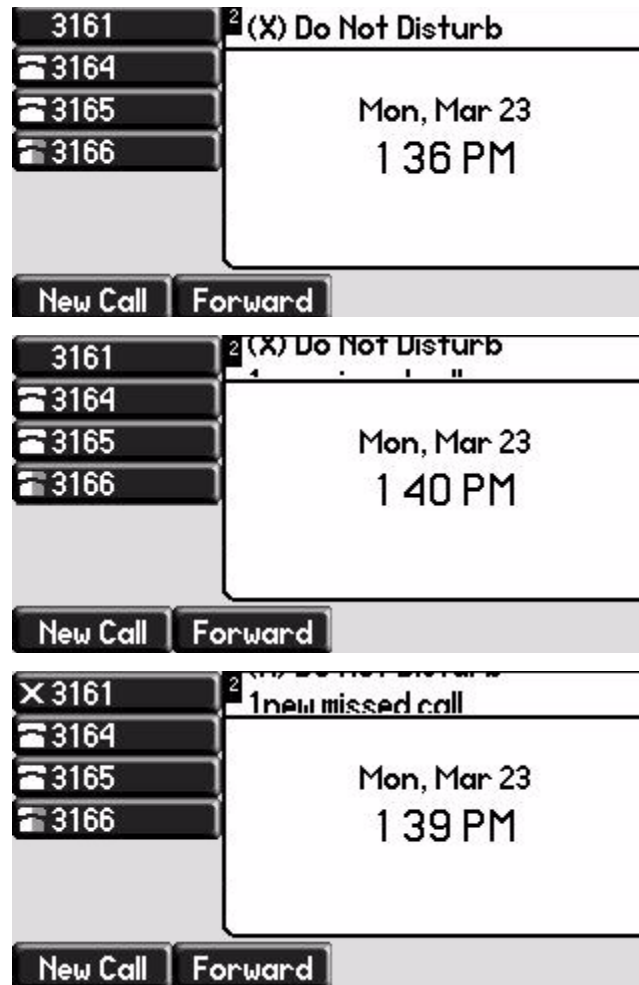

Using a USB Device to Record Calls

If the Call Recording and Playback feature is available and you plug a removable USB device into the USB port on your SoundPoint IP 670, you can record active calls on your phone.

The USB port is on the back of your SoundPoint IP 670 as shown below:

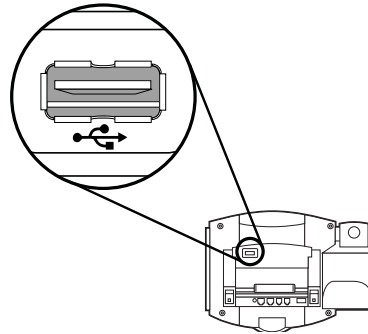

When you plug in the USB device, the USB device is supported and the message “USB device attached.” appears.

When you remove the USB device, the message “USB device removed.” appears.

Note

Wait until the “USB device removed.” message disappears before plugging in another USB device. If you plug in a new USB device before the message disappears, it will not be recognized.



Polycom recommends that you do not remove the USB device while recording. The file being recorded at that time will be incomplete and cannot be played back later. There is a small probability that the USB device itself may be damaged by this action.

Cleaning the LCD Glass

Clean the glass with a clean lint-free cloth. Fingerprints tend to show up more obviously on the color LCD.

Customizing Your Phone

You can customize your SoundPoint IP 670 desktop phone by adjusting the setting for time and date, display contrast, and ring type, for example. You can add contacts to the phone's directory manually or from call lists. You can handle incoming calls from different contacts in different ways.

This chapter provides basic operating instructions for customizing your SoundPoint IP 670 phone. This chapter contains:

- [Configuring Basic Settings](#)
- [Managing Call Lists](#)
- [Managing Contacts](#)
- [Managing Incoming Calls](#)

Some customizations of your SoundPoint IP 670 phone are performed by your system administrator. These include:

- [Supporting Multiple Lines](#)
- [Supporting Multiple Line Keys Per Line](#)
- [Supporting Shared Lines](#)

To read about the phone's basic features, refer to [Using the Basic Features of Your Phone](#) on page 3-1. To read about the phone's advanced features, refer to [Using the Advanced Features of Your Phone](#) on page 4-1. To add a SoundPoint IP Color Expansion Module to your SoundPoint IP 670 phone, refer to [Using the SoundPoint IP Color Expansion Module](#) on page 5-1.

If you require additional information or assistance with your new phone, contact your system administrator.

Configuring Basic Settings

You can configure the following basic settings through use of  :

- Appearance of the time and date
- Display contrast
- Backlight intensity
- Headset Memory Mode
- Headset hookswitch selection
- Ring type
- Language support (localization)
- Background pattern
- Soft key label color

You can mute the microphone and adjust the volume using separate keys.

Changing the Appearance of Time and Date



The time and date appears on the graphic display of the SoundPoint IP 670 phone. If the phone cannot obtain a time and date from the call server, the display will flash. Contact your system administrator if either the time or date is incorrect.

You can select from various formats for the time and date display. Select and set options that are right for you. You can also disable the time and date display, so the time and date do not display on the phone screen.





To configure the time and date formats:

1. Press  .
2. Select **Settings > Basic > Preferences > Time & Date**.
3. Select from **Clock Date, Clock Time, Clock Order, or Enable/Disable**.

4. Using  and , scroll through the options under each of these selections.
5. Press the **Select** soft key to confirm your choice.

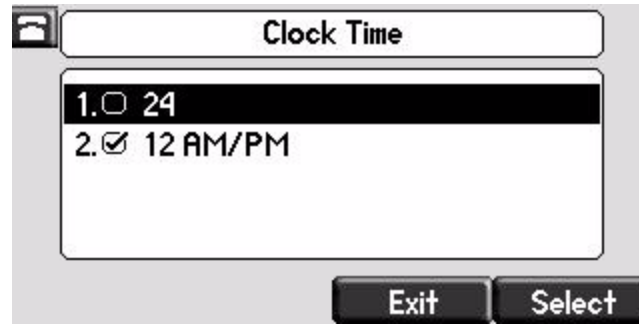
The following figure shows the Clock Time menu.



6. Press  to return to the idle display.

Changing the Display Contrast

To adjust the contrast on the display to a comfortable level:

1. Press .
2. Select **Settings > Basic > Contrast**.

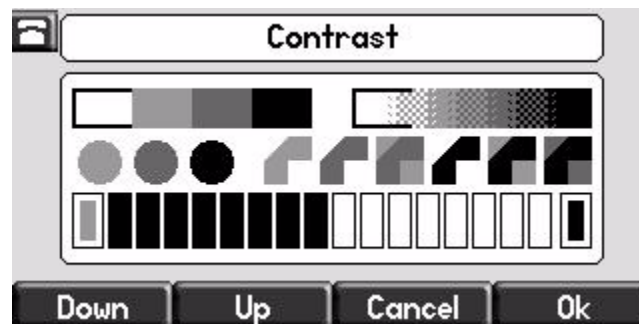

3. Press the **Up** or **Down** soft keys to increase or decrease the display contrast.

Note

You can also use the volume keys to increase or decrease the display contrast.

4. Press the **Ok** or **Cancel** soft keys to accept or cancel changes.
5. Press  to return to the idle display.

Changing the Backlight Intensity

Backlight intensity on the SoundPoint IP 670 phone has three components:

- Backlight On
- Backlight Idle
- Maximum Intensity

You can modify the Backlight On intensity and the Backlight Idle intensity separately. You can select high, medium, low, and off levels for both.

When you modify the Maximum Intensity, you are modifying the entire backlight intensity scale. For example, if you decrease the Maximum Intensity, the low, medium, and high values for both Backlight On intensity and the Backlight Idle intensity decrease.

If you have attached one or more SoundPoint IP Expansion Modules to your SoundPoint IP 670 and you find that the backlight levels between them are incompatible, you can modify the maximum backlight intensity on a unit-by-unit basis. This allows you to match all Expansion Module backlights to an overall consistent level. For more information, refer to [Using the SoundPoint IP Color Expansion Module](#) on page 5-1.

The Backlight On intensity applies for the following events:

- Any key press
- Hookswitch release
- Incoming calls
- Ending a call, holding a call, resuming a call by the other party
- A voice or instant message received

If you do not press any keys on the phone after 20 seconds of the backlight turning on, the backlight dims (or changes) to medium in the following cases:

- A call is in progress
- A call is on hold
- There is an incoming call (ringing)
- There is an outgoing call (ringing back)
- Any menu shows on the display

In all other cases, the Backlight Idle intensity applies.

To modify the backlight intensity:

1. Press  .

2. Select **Settings > Basic > Backlight Intensity**.
3. Select **Backlight On Intensity**.



4. Use or to select high, medium, low, or off, and then press the **Select** soft key.
The default level is medium.
5. Select **Backlight Idle Intensity**.



6. Use or to select high, medium, low, or off, and then press the **Select** soft key.
The default level is low.
7. Select **Maximum Intensity**.

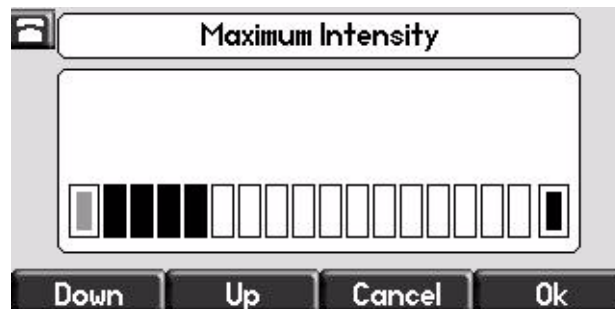



8. Press the **Up** or **Down** soft keys to increase or decrease the backlight intensity.

9. Press the **Ok** or **Cancel** soft keys to accept or cancel changes.
10. Press  to return to the idle display.

Enabling the Headset Memory Mode

This feature is especially useful for permanent or full-time headset users.

To permanently enable the Headset Memory Mode:

1. Press .
2. Select **Settings > Basic > Preferences > Headset... > Headset Memory...**
3. Use  or  to select Enabled, and then press the **Select** soft key.

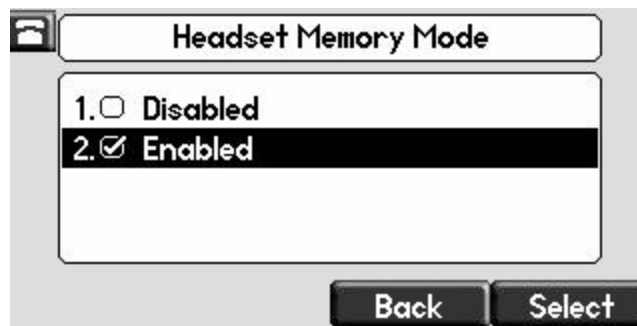

4. Press  to return to the idle display.

Repeat steps 1 to 4 to select Disabled and turn Headset Memory Mode off.

To activate Headset Memory Mode:

- >> Press  twice.

The flashing headset icon on the graphic display or a flashing headset key indicates that the headset mode is activated. Pressing  or the **Answer** soft key to receive a call will now connect to your headset automatically.



Selecting the Correct Headset for Electronic Hookswitch

This feature allows you to answer your phone when you are using a headset.



For information on supported headsets to provide electronic hookswitch features for placing, answering, and ending calls, go to www.polycom.com/support/voice and enter "Headset Compatibility List" in the Knowledge Base text box or contact your system administrator.

To select a headset that supports electronic hookswitch:

1. Press .
2. Select **Settings > Basic > Preferences > Headset > Analog Headset Mode**.
3. Use  or  to select your headset, and then press the **Select** soft key.

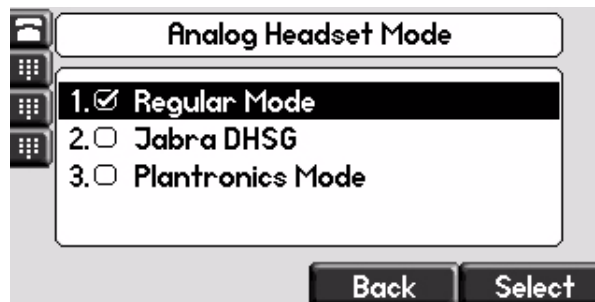





4. Press  to return to the idle display.

Selecting the Ring Type

You can select different ring types to distinguish lines or to distinguish your phone from your neighbor's phone.

To change the incoming ring type:

1. Press .
2. Select **Settings > Basic > Ring Type**.
3. (Optional.) If multiple lines are configured on your phone, first select the line to change from the list using the  and .

4. Use  and  to select the desired ring type.

To hear the selected ring type, press the **Play** soft key.



5. Press the **Select** soft key to change to the selected ring type.
6. Press  to return to the idle display.



Note

If you configure your SoundPoint IP 670 phone with a silent ring, press the flashing Line key or the **Answer** soft key to answer the call. If your handset is off hook, the call is routed to the handset. If your handset is on hook, the call is routed to the speaker.

Changing the Language

Many languages are supported by the SoundPoint IP 670 phone.

To change the language:

1. Press .
2. Select **Settings > Basic > Preferences > Language**.
3. Use  and  to highlight the language you want.



4. Press the **Select** soft key.

Text that appears on the graphic display will change to the language of your choice.

5. Press  to return to the idle display.

Changing the Graphic Display Background

You can change the picture or design design that appears on the graphic display. A default background displays when the phone starts up (shown below). For more information on selections, contact your system administrator.



To change the graphic display background:

1. Press .
2. Select **Settings > Basic > Preferences > Backgrounds**.

Note

Under certain circumstances, you may need make an additional menu selection, **Select Background**, to actually select the background.

If your system administrator has configured the phone's idle browser and you want to view the background and not the idle browser, you can turn off the idle browser by doing the following:

- Select **Background > Prioritize Background**.
- Select **Enable** and press the **Select** soft key.

3. Use  and  to highlight the background you want.



Note

When previewing the backgrounds, only the phone's display is updated. The Expansion Module's display is updated only when the new background is selected.

4. Press the **Select** soft key.
5. Press  to return to the idle display.

Changing the Soft Key Label Color

You can change the soft key label color that appears on the graphic display. A default soft key label color displays when the phone starts up (shown below). For more information on selections, contact your system administrator.



To change the soft key label color:

1. Press  .

2. Select **Settings > Basic > Preferences > Label Color**.

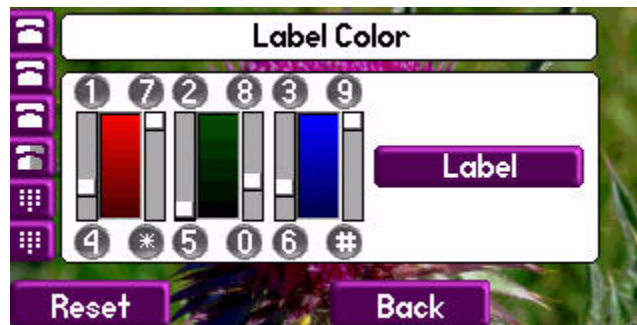

Using the dial pad keys 1, 4, 7, and * change the red hues. Using the dial pad keys 2, 5, 8, and 0 change the green hues. Using the dial pad keys 3, 6, 9, and # change the blue hues. The **Label** soft key on the right reflects your changes.

Note

When the color of the label reaches a certain level of whiteness, "Cannot save this color. Text might be unreadable." appears. This popup appears only the first time the color reaches that level.

3. Press the **Save** soft key.

Press the **Reset** soft key to reset the color to the default color.

Press the **Undo** soft key to undo your last change.

4. Press  to return to the idle display.

Muting the Microphone

During a call, press . The Message Waiting Indicator turns red and a microphone on the screen indicates that the other party (or parties) cannot hear you.

Microphone Mute applies to all modes: Handset, Headset, and Hands-free Speakerphone. You can still hear all other parties while mute is enabled.

To turn off Microphone Mute, press  again.

Adjusting the Volume

Press  to adjust receiver volume during a call. Pressing these keys in the idle state adjusts the ringer volume.

Note

To conform to regulatory requirements, handset and headset volume will return to a preset level after each call, but your system administrator can change this. Hands-free Speakerphone volume settings will be maintained across calls.

Managing Call Lists

Your phone maintains local lists of missed, received, and placed calls. Each list contains 100 entries.

Press  followed by **Call Lists > Missed Calls, Received Calls, or Placed Calls**. The following shows a Placed Calls list.



Manage the call list by doing the following:

- To edit the phone number, press the **Edit** soft key.
- To return the call, press the **Dial** soft key.
- To view information about the call, press the **More** soft key followed by the **Info** soft key.
- To store the contact in the Contact Directory, press the **More** soft key followed by the **Save** soft key.
- To delete the call from the list, press the **More** soft key followed by the **Clear** soft key.

Press  to return to the idle display.

Note

Press the **Right** arrow key from the idle display to access the Placed Calls list. Press the **Left** arrow key from the idle display to access the Received Calls list. Press the **Down** arrow from the idle display to access the Missed Calls list. You can use these shortcuts while placing calls or performing transferring and conferencing functions.

Note

You can manually clear all call lists. They are automatically cleared when you restart the phone.

Managing Contacts

You can store a large number of contacts in your phone's local contact directory. Contact your system administrator for the exact number.

You can dial or search for a contact in this directory. You may be able to add, edit, and delete contacts.



You may have access to your corporate directory through your phone. Your system administrator determines which contacts you have access to. You can place calls to contacts in your corporate directory. You may be able to add contacts from the corporate directory to your local contact directory.

Adding Contacts

You can add contacts to your contact directory:

- Manually
- From a call list
- From your corporate directory

Adding Contacts Manually

To add a contact to the local contact directory manually:

1. Press **Directories**.
2. Select **Contact Directory**.
3. Press the **More** soft key.
4. Press the **Add** soft key.
5. Enter first and/or last name of the contact from the keypad.



Use the **1/A/a** soft key to select between numeric and upper/lower case alphanumeric modes.

Use the **Encoding** soft key to access special characters in other languages.









6. Enter a contact number.
This is a required field and it must be unique (not already in the directory).
7. (Optional.) Change the Speed Dial Index field.
It is automatically assigned to the next available index value.
For more information, refer to [Assigning Speed Dial Keys](#) on page 3-23.



8. (Optional.) Change the Ring Type and Divert Contact fields.
These fields may be left blank.
For more information on setting the Ring Type field, refer to [Distinguishing Calls](#) on page 2-21.
For more information on diverting contacts, refer to [Diverting Calls](#) on page 2-23.
9. (Optional.) Change the Auto Reject, Auto Divert, Watch Buddy, and Block Buddy fields.
Use  and  to switch between Enabled and Disabled settings.
For more information on setting the Auto Reject field, refer to [Rejecting Calls](#) on page 2-22. For more information on setting the Watch Buddy and Block Buddy fields, refer to [Managing Buddies](#) on page 4-6.
10. Press the **Save** or **Cancel** soft keys to accept or cancel changes.
11. Press  to return to the idle display.

Adding Contacts From Call Lists

To add a contact to the local contact directory from a call list:

1. Do one of the following:
 - Press  .
Select **Call Lists >Missed Calls**, **Received Calls**, or **Placed Calls** as desired.
 - Press , , or  to access the desired call list.
2. Use  and  to highlight the contact.
You can also use the * key to Page Up and the # key to Page Down.
3. Press the **More** soft key, and then the **Save** soft key to save the contact in the phone's directory.



4. Press  to return to the idle display.

Note

You may want to go to the local contact directory to check if the contact was saved correctly, and to add any missing fields.

Adding Contacts From the Corporate Directory

To add a contact to your local contact directory from the corporate directory:

1. Press  .
2. Select **Corporate Directory**.
3. Search for the contact.
Refer to [Searching the Corporate Directory](#) on page 2-19.
4. Press the **View** soft key.

The contact's information appears on the graphic display.





5. Press the **Save** soft key to save the contact in the local contact directory.
"Entry saved" appears on the graphic display. Only the first name, last name, and phone number are saved.
If the contact already exists in the contact directory, "Entry already exists" appears.
6. Press  to return to the idle display.

Editing Contacts

To edit a contact in the local contact directory:

1. Press  .

2. Select **Contact Directory**.
3. Use  and  to highlight the contact.
You can also use the * key to page up and the # key to page down.
4. Press the **Edit** soft key
5. Edit the contact information.







6. Press the **Save** or **Cancel** soft keys to accept or cancel changes.
7. Press  to return to the idle display.

Note

You can quickly edit a contact associated with a speed dial key by pressing and holding the contact's speed dial key, and then complete steps 5 to 7.



Deleting Contacts

To delete a contact from the local contact directory:

1. Press .
2. Select **Contact Directory**.
3. Use  and  to highlight the contact.
You can also use the * key to page up and the # key to page down.
4. Press the **More** soft key twice, and then press the **Delete** soft key.
The contact is deleted from the directory.
5. Press  to return to the idle display.

Placing Calls to Contacts

To place a call to a contact in the local contact directory:

1. Press  .
2. Select **Contact Directory**.
3. Use  and  to highlight the contact.
You can also use the * key to page up and the # key to page down.
4. Press the **Dial** soft key.

To place a call to a contact in the corporate directory:

1. Press  .
2. Select **Corporate Directory**.
3. Search for the contact.
Refer to [Searching the Corporate Directory](#) on page 2-19.
4. Press the **View** soft key.

The contact's information appears on the graphic display.



5. Press the **Dial** soft key.

Searching for Contacts

Searching the Contact Directory

To search for a contact in the local contact directory:

1. Press  .

2. Select **Contact Directory**.
3. Press the **More** soft key, and then the **Search** soft key.
4. Using the dial pad, enter the first few characters of the contacts' first or last name.



5. Press the **Search** soft key again.

You can dial any successful matches from the resulting information on the graphic display.

Searching the Corporate Directory

To search for a contact in the corporate directory:

1. Press .
2. Select **Corporate Directory**.

Note

You can enable your phone to save Corporate Directory search results, and to remember the last person you viewed in the directory. Whenever you redisplay Corporate Directory, the last person you viewed will display. If you searched for a person, the results of the last search you submitted will display. To enable this feature, press the **Menu** key, and then select **Settings > Basic > Preferences > Corporate Directory > View Persistency**. Select **Enabled**, press the **Select** soft key, and then press the **Menu** key to exit the menu.

3. Search for the contact in one of the following ways:

- In the search line, enter the first few characters of the contacts' last name using the dial pad. For example, to search for Carol Woller, enter **wo** in the search line.



Press the **Submit** soft key. In this example, Carol Woller appears in the search results.



If no entries in the corporate directory match the search parameters, "No entries found." appears.

- Press the **AdvFind** soft key, enter search values in the displayed fields. For example, enter **Byron Smith** as the first name and last name.

Press the **Submit** soft key. In this example, Bryon Smith appears in the search results.

You can dial any successful matches from the resulting information on the graphic display.

Managing Incoming Calls

You can distinguish incoming calls by setting distinctive rings for contacts in your contact directory, sending particular calls directly to your voice mail, or transferring particular calls to another party.



Distinguishing Calls

You can customize your phone so that you can distinguish different parties by ring type.

Note

This feature is local to the phone, and may be overridden by your organization's settings. For more information, contact your system administrator.

To set a distinctive ring type for a contact:

1. Press **Directories**.
2. Select **Contact Directory**.
3. Use  and  to highlight the contact.
You can also use the * key to page up and the # key to page down.
4. Press the **Edit** soft key, and then scroll to the Ring Type field.



5. Enter the number corresponding to one of the ring types available.
For more information, refer to [Selecting the Ring Type](#) on page 2-7.
6. (Optional.) To remove an existing value, press .
7. Press the **Save** or **Cancel** soft keys to accept or cancel changes.
8. Press **Directories** to return to the idle display.



Rejecting Calls

You can customize your phone so that incoming calls from a particular party are immediately sent to your voice mail.

Note



Rejecting calls is not available on shared lines.

To send incoming calls from a contact directly to voice mail:

1. Press **Directories**.
2. Select **Contact Directory**.
3. Use  and  to highlight the contact.
You can also use the * key to page up and the # key to page down.

4. Press the **Edit** soft key, and then scroll to the Auto Reject field.





5. Use  and  to select Enabled.
6. Press the **Save** or **Cancel** soft keys to accept or cancel changes.
7. Press  to return to the idle display.

Diverting Calls



You can customize your phone so that incoming calls from a particular contact are transferred directly to a third party.

To divert incoming calls from a particular contact:

1. Press .
2. Select **Contact Directory**.
3. Use  and  to highlight the contact.
You can also use the * key to page up and the # key to page down.
4. Press the **Edit** soft key, and then scroll to the Divert Contact field.



5. Enter the number of the party to whom you want to divert the call.
6. Scroll to the Auto Divert field.

7. Use  and  to select Enabled.
8. Press the **Save** or **Cancel** soft keys to accept or cancel changes.
9. Press  to return to the idle display.

System Customizations

The following section details how your system administrator can customize your SoundPoint IP 670 phone.

Supporting Multiple Lines

Your SoundPoint IP 670 phone can support up to 34 lines with or without a SoundPoint IP Color Expansion Module. For more information, refer to [Using the SoundPoint IP Color Expansion Module](#) on page 5-1.

Typically, the top-most Line Key is reserved for the principal directory number (DN) of the phone.

Depending on how your administrator sets up your phone, the display could resemble one of the following:

- One line, 3163

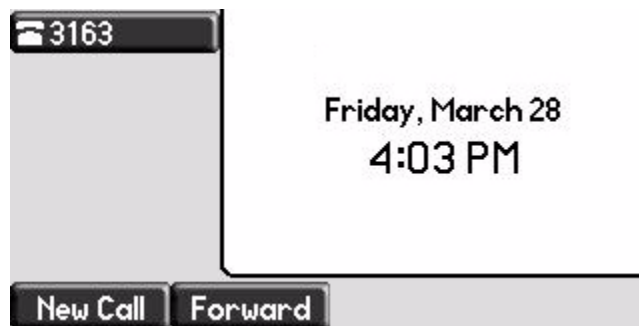

- Two lines, 3161 and 3163

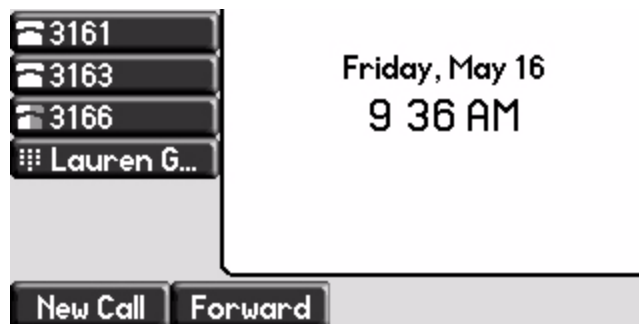

Supporting Multiple Line Keys Per Line

Each line on the phone can be configured to have more than one Line Key associated with it. This enhances call visualization and simplifies call handling. If this is the case, the display could resemble the following figure:

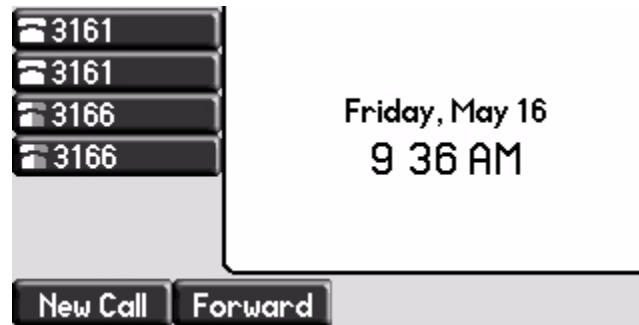

Incoming calls to this line will be distributed evenly among the available Line Keys. Similarly, outgoing calls will be distributed.

Your phone can be configured to have a combination of lines with a single Line Key and lines with multiple Line Keys.

Supporting Shared Lines

Your SoundPoint IP 670 phone supports shared lines.

Note

Shared lines are an optional feature and may not be supported on your particular system. For more information, contact your system administrator.

A shared line is indicated by a different line icon. In the following figure, the lines 3161 and 3163 are private and the line 3166 is shared.

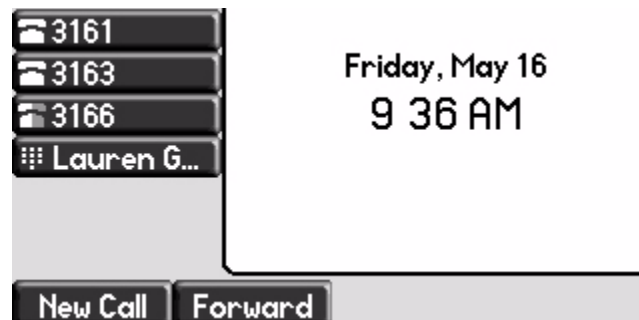

If two phones share a line, an incoming call to that number will cause both phones to ring. The call can be answered on either phone but not both.

Calls on shared lines can be transferred, put on hold, or added to a conference.

Note

Call Forwarding is not available on shared lines.

Do Not Disturb (DND) on shared lines disables the ringing option only. The visual indication is still in place.

Using the Basic Features of Your Phone

Your SoundPoint IP 670 desktop phone is designed to be used like a regular phone on a public switched telephone network (PSTN). You can place calls, transfer a call to someone else, or conduct a conference call.

At any time, at most one active call may be in progress on your phone. The active call is the one that has audio associated with it. There may be multiple other calls:

- On hold
- In an “Incoming call” or “Ringing” state

This chapter provides basic operating instructions for the SoundPoint IP 670 phone. The topics include:

- [Placing Calls](#)
- [Answering Calls](#)
- [Ending Calls](#)
- [Redialing Numbers](#)
- [Placing Calls on Hold](#)
- [Hosting Conference Calls](#)
- [Transferring Calls](#)
- [Forwarding Calls](#)
- [Enabling Do Not Disturb](#)
- [Assigning Speed Dial Keys](#)
- [Using Voice Mail](#)

To customize your phone, refer to [Customizing Your Phone](#) on page 2-1. To read about the phone's advanced features, refer to [Using the Advanced Features of Your Phone](#) on page 4-1. To add a SoundPoint IP Expansion Module to your SoundPoint IP 670 phone, refer to [Using the SoundPoint IP Color Expansion Module](#) on page 5-1.

If you require additional information or assistance with your new phone, contact your system administrator.

Placing Calls

You can place a call in many ways using your SoundPoint IP 670 phone:

- Using the handset
- Using the speakerphone
- Using the headset

You can also dial the number first—called “hot dialing”—and then choose the method you will use to speak to the other party.

You can search the call lists, the local contact directory or the corporate directory and dial from the search results page. For more information, refer to [Managing Call Lists](#) on page 2-12 and [Managing Contacts](#) on page 2-13.

During a call, you can alternate between Speakerphone Hands-Free, Headset, or Handset modes by pressing the  or  keys, or picking up the handset.

The call duration of active calls is visible within the active call window on the graphic display. In the figure below, the call to Greg Slowski has lasted 1 minute and 4 seconds.



To place a call using the handset:

>> Do the following steps in any order:

- Pick up the handset.
- Dial the number using the dial pad.

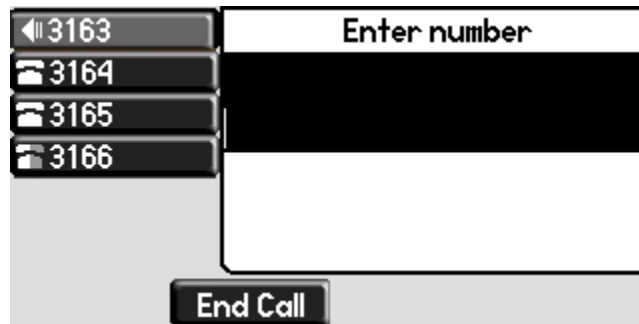
**Note**

You can also dial using the SIP URL or IP address. To obtain the IP address of your phone, press the **Menu** key, and then select **Status > Platform > Phone**. The IP address is listed together with other phone information. The maximum URL or IP address length is 32 characters. For example, 10.3.0.42, sip:jane@polycom.com . Press the **URL** soft key and enter the URL or IP address. Use * for "." and # for "@". Then press the **Send** soft key to complete the call.

Your phone may not support SIP URL or IP address dialing. Contact your system administrator.

To place a call using Hands-Free Speakerphone mode:**Note**

If "Handsfree mode disabled" appears on the graphic display after you press the speakerphone key, your system administrator has disabled the speakerphone on your phone.

>> Do one of the following:

- With the handset on-hook, press , or the **New Call** soft key to obtain a dial tone.

Dial the number using the dial pad.

- With the handset on-hook, dial the number using the dial pad.

Press , or the **Dial** soft key.

To place a call using the headset:

>> Do one of the following:

- With the optional headset connected, press  or the **New Call** soft key to obtain dial tone.

Press .

Dial the desired number using the dial pad.

- With the optional headset connected, dial the desired number using the dial pad.

Press .

Note

To permanently enable your headset, refer to [Enabling the Headset Memory Mode](#) on page 2-6.

Answering Calls

When you are not in another call, you can answer a call in three ways:

- Using the handset
- Using the speakerphone
- Using the headset

The steps for answering an incoming call when you are in another call are different if your phone is configured for:

- A single Line Key per line



- Multiple Line Keys per line

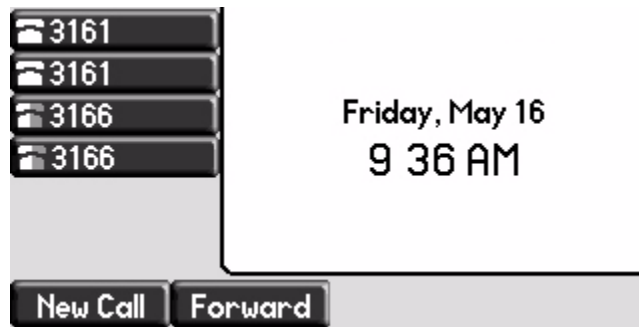

If your phone is configured with multiple call appearances, refer to [Using Multiple Call Appearances](#) on page 4-1 for instructions on how to answer a call.

Note

You can ignore incoming calls by pressing the **Reject** soft key (for private lines) or the **Silence** soft key (for shared lines) or the **Do Not Disturb** key. The Do Not Disturb mode stays active when the call ends and remains active until you press the **Do Not Disturb** key again.

You can forward incoming calls by pressing the **Forward** soft key. For more information, refer to [Dynamic Forwarding](#) on page 3-21.

When your phone is configured with a silent ring, press the ringing Line key or the **Answer** soft key to answer the call. If your handset is off-hook, the call is routed to the handset. If your handset is on-hook, the call is routed to the speaker.

Answering When Not in Another Call

In all cases, the active call will appear on the graphic display showing call duration and destination.

To answer a call using the handset:



>> Pick up the handset.

To answer a call using Hands-Free Speakerphone mode:

Note

If “Handsfree mode disabled” appears on the graphic display after you press the speakerphone key, your system administrator has disabled the speakerphone on your phone.

>> Do one of the following:

- Press .
- With the handset on-hook, press  (next to the flashing green status indicator).

- Press the **Answer** soft key.

To answer a call using the headset:

>> Press  .

If Headset Memory Mode is activated, press  or the **Answer** soft key.

Answering When in Another Call

If you have an active call, and an incoming call arrives on the same line, do one of the following:

- If your phone is configured for a single Line Key per line:
 - You may hear a call waiting tone, and you will see the second call appearance. Caller information for the incoming call appears on the graphic display.
- If your phone is configured for multiple Line Keys per line:
 - You may hear a call waiting tone, the second Line Key indicator fast flashes green, and an incoming call icon appears. Caller information for the second Line Key appears on the bottom line of the graphic display.
- If your phone is configured for shared lines:
 - You may hear a call waiting tone, the second Line Key indicator will fast flash green, and an incoming call icon appears on the second Line Key.

Note

If your phone is configured for shared lines, the **Reject** soft-key is replaced by a **Silence** soft key and there is no **Forward** soft-key. To stop the incoming call from ringing, press the **Silence** soft key.

To answer an incoming call on a line configured for a single Line Key:

>> Do one of the following:

- Press  or the **Hold** soft key to put the original call on hold.

The incoming call is answered.

- Press  to access the new call.

Press the **Answer** soft key.

The original call is placed on hold.

Note

You can forward incoming calls by pressing the **Forward** soft key. For more information, refer to [Dynamic Forwarding](#) on page 3-21.

To answer an incoming call on a line configured for multiple Line Keys:

>> Do one of the following:

- Press  next the flashing green indicator.

The first call is placed on hold and the second call become the active call.

- Press  or the **Hold** soft key to place the original call on hold.

Press the **Answer** soft key.

Note

You can forward incoming calls by pressing the **Forward** soft key. For more information, refer to [Dynamic Forwarding](#) on page 3-21.

To answer an incoming call on a shared line:



1. Answer the incoming call.
2. Press  or the **Hold** soft key.

Anyone on another phone configured to use the same shared line may take the call by selecting the Line Key associated with the call on hold (represented by a flashing red LED).

Ending Calls

To end a call:

>> Do one of the following:

- If you are using the handset, press the **EndCall** soft key or replace the handset.
- If you are using a headset, press .
- If your are using the speakerphone, press .

Redialing Numbers

To redial the last call placed from your phone:

>> Press  .

A call to your last placed call is attempted.



To redial a previously placed call, refer to [Managing Call Lists](#) on page 2-11.

Placing Calls on Hold

During a call, press  or the **Hold** soft key. The hold icon will display on the line key label.





Press  again or the **Resume** soft key to retrieve the call. The registered line icon appears as the line indicator.

Note

The Hold feature typically generates music or a beeping tone. Therefore, avoid putting a conference call on hold.

Multiple Calls on Hold

If multiple calls are on hold on a single Line Key, use  and  to switch between the calls, and then press the **Resume** soft key to retrieve the desired call.



If more than two calls are on hold on a single Line Key, an indication appears on the graphic display, for example “2/3”, indicating that this is the second call out of three calls.

If calls are on hold on more than one Line Key, you can view the details of the calls on any Line Key by pressing and holding the Line Key for more than two seconds. If a Line Key is depressed for less than one second, the first call on hold on that Line Key will be retrieved.

Hosting Conference Calls

You can create a conference with other parties using the phone’s local conference feature. You can create a conference at any time between an active call and a call on hold (on the same or another line) by pressing the **Join** soft key. The conference management feature allows you to view all parties in a conference call. From the Manage Conference page, you can add, hold, remove, and mute specific conference parties.

Note

The conference management feature is an optional feature and may not be supported on your particular system. For more information, contact your system administrator.

This section provides the following step-by-step instructions:

- [Setting Up Conference Calls](#)
- [Managing Conferencing Calls](#)
- [Adding Parties to Conference Calls](#)
- [Joining Conferences](#)

- [Splitting Conference Calls](#)
- [Ending Conferencing Calls](#)

Setting Up Conference Calls

To set up a conference call:

1. Call the first party.

Note

You can either dial the phone number directly or search for the number in the Contact Directory or Call Lists. For more information, refer to [Placing Calls](#) on page 3-2, [Searching for Contacts](#) on page 2-19, or [Managing Call Lists](#) on page 2-12.

2. Press  or the **Confrcnc** soft key to create a new call.

The active call is placed on hold.

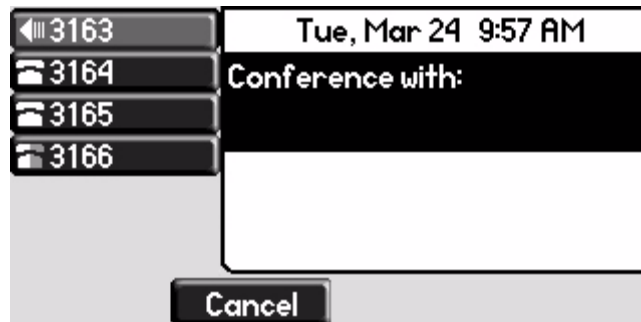

Note

If configured for single key-press conferences, all conference participants hear the dial tone and ringback when the conference host places a call to a new party.

3. Call the second party.

4. When the second party answers, press **Conference** or the **Confnc** soft key again to join all parties in the conference.

**Note**

If configured for single key-press conferences, you do not need to press the **Confnc** soft key again.

5. Press **Conference** or the **Confnc** soft key to add another party to the conference.

The first and second party are put on hold.

Note

If configured for single key-press conferences, all conference participants hear the dial tone and ringback when the conference host places a call to a new party.

6. Call the third party.
7. After the third party answers, press **Conference** or the **Confnc** soft key again to join all parties in the conference.

Note

If configured for single key-press conferences, you do not need to press the **Confnc** key again.

A conference similar to this one will now exist.

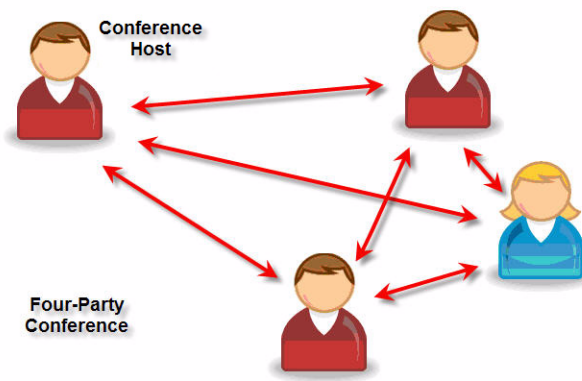

- Repeat steps 5 to 7 until you have added all intended parties.

Managing Conferencing Calls

To manage a conference call:

You are currently in a conference call.

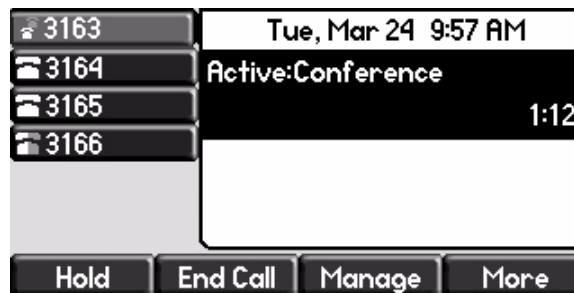

- Press the **Manage** soft key.

The Manage Conference page appears.

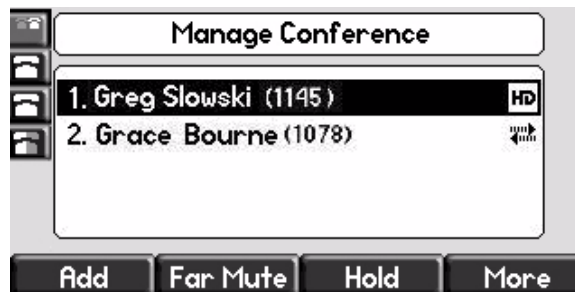

Press the **More** soft key to see the **Remove**, **Info**, and **Back** soft keys.

Press the **Info** soft key to view more information about the selected party.

Press the **Back** soft key to exit the conference management feature.

2. Do one of the following:

- To add a new party, press the **Add** soft key.

Call another party as you would using **Conference** or the **Confnc** soft key (outside the conference management feature). The other parties are put on hold.

After the new party answers, press **Conference** again to join all parties in the conference.

Note

The **Add** soft key appears only if you can add more parties to the conference call. Your system administrator determines the maximum number of conference participants. The default number is three. For more information, contact your system administrator

- To mute a party, select the party, then press the **Far Mute** soft key.



The muted party can hear all parties, but no party can hear the muted party.

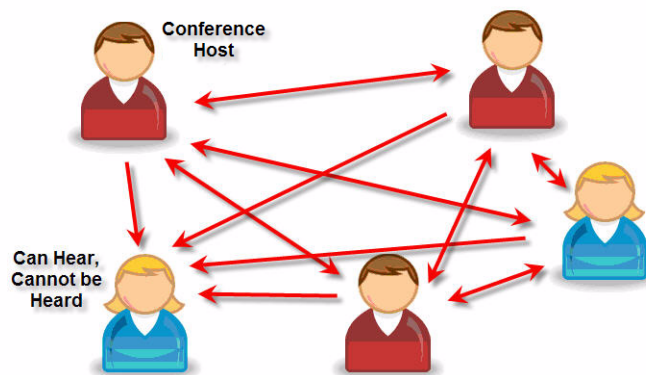

If you press  instead of the **Far Mute** soft key, all other parties can hear each other, but they cannot hear you.

Press the **UnMute** soft key to un-mute the party.

- To place a party on hold, select the party, and then press the **Hold** soft key.

The held party cannot hear any parties and no party can hear the held party.

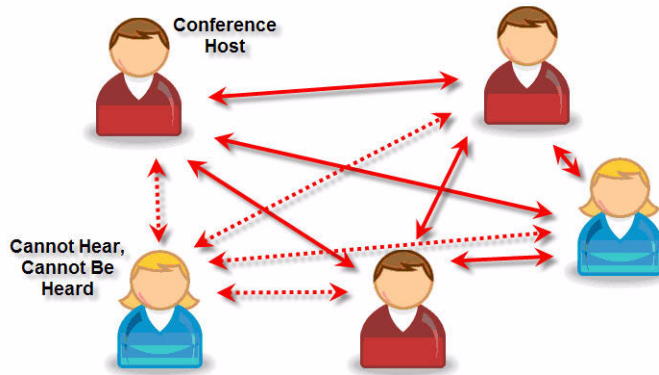

Press the **Resume** soft key to return the party to the conference.

If the held party presses **Hold** on their phone, the party will remain on hold within the conference even if you press the **Resume** soft key.

- To remove a party from the conference, press the **Remove** soft key.
The party is removed from the conference. To return the party to the conference, press the **Add** soft key (refer to the first optional step above).

Adding Parties to Conference Calls

To add a party to a conference call using the Join soft key:

You are currently hosting a conference call between a number of parties.

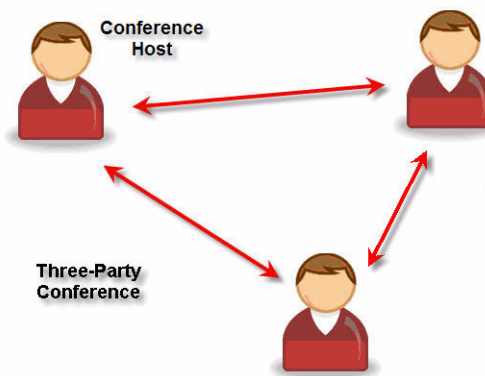

To add a party to a conference call using the Join soft key:

1. From the Manage Conference page, press  or the **Hold** soft key.

The other parties in the conference call are placed on hold.

Note

If configured for local conference hold, the other parties in the conference call can continue to speak with each other while you place the new call.

2. Press the **New Call** soft key.
3. Place a call to a new party.
4. After the new party answers, press the **Join** soft key.
All parties in the conference call can now hear each other.

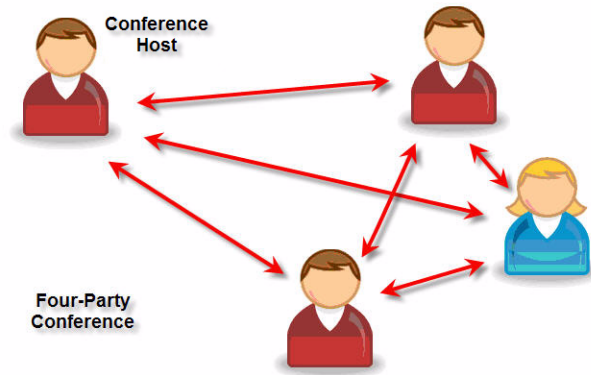

Joining Conferences

To join two conferences:

Previously you set up two separate conference calls between a number of parties. Only one conference can be active at a time.

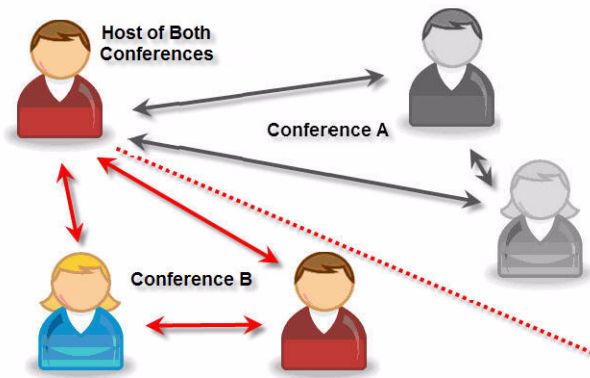

>> From the idle display, press the **Join** soft key.

Both conferences are joined into a single five-way conference.

Splitting Conference Calls

To split a conference call:

>> From the Active Conference page, press the **More** soft key, and then press the **Split** soft key to split the conference.

All calls are split into individual calls and put on hold.

Ending Conferencing Calls

To end a conference call:

>> From the Active Conference page, press the **End Call** soft key or hang up.

The other parties will continue to be connected.

Transferring Calls

A call can be transferred in one of three ways:

- Consultative transfer – The party to whom you want to transfer the call answers their phone before you transfer the call or hang up. You can consult with them before completing the transfer.
 - [Performing a Consultative Transfer](#) on page 3-17.
- Blind transfer – The call is automatically transferred after you dial the number of the party to whom you want to transfer the call.
 - [Performing a Blind Transfer](#) on page 3-18.
- Attended transfer – The parties are automatically connected to each other after you exit the conference.
 - Set up a conference call and then end your participation. For more information, refer to [Hosting Conference Calls](#) on page 3-9.

Performing a Consultative Transfer

To transfer a call:

1. During a call, press the  or the **Transfer** soft key.

The active call is placed on hold.

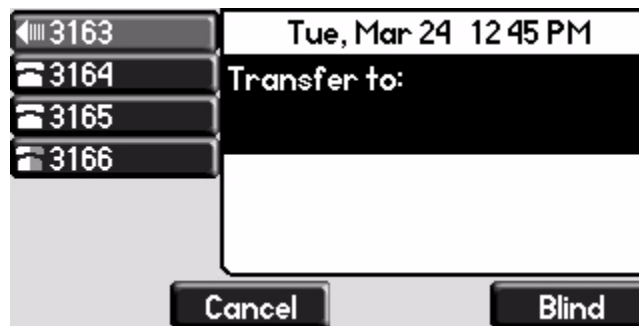

2. Do one of the following:
 - Enter the number to which you want to transfer the call.
 - Refer to [Placing Calls](#) on page 3-2.

3. As soon as you hear the ring-back sound or after the party answers (and you speak to the party), press  or the **Trnsfer** soft key.



You can talk privately to the party to which you are transferring the call before the transfer is completed.

If you are using a handset, the transfer can be completed by putting the handset on the cradle.

You can cancel the transfer before the call connects by pressing the **Cancel** soft key.

Performing a Blind Transfer

To perform a blind transfer:

1. During a call, press  or the **Trnsfer** soft key.
2. Press the **Blind** soft key.

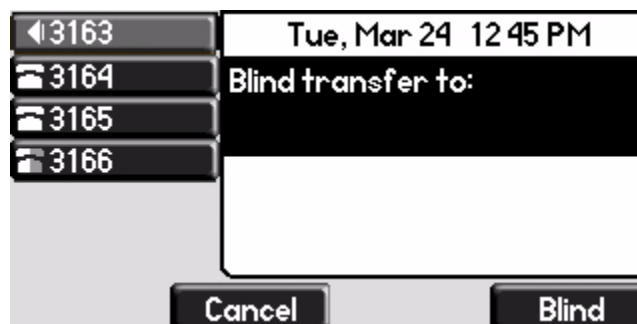

3. Do one of the following steps:
 - Enter the number to which you want to transfer the call.
 - Refer to [Placing Calls](#) on page 3-2.

At this point, the call is connected to the number to which you are transferring them.

Forwarding Calls

You can configure your phone so that all incoming calls are forwarded to another party (refer to [Static Forwarding](#)). You can also forward calls while your phone rings (refer to [Dynamic Forwarding](#)).

You can forward all incoming calls to another party while Do Not Disturb is enabled on your phone. For more information, contact your system administrator.

Note

Call Forwarding is not available on shared lines.

This feature is local to the phone, and may be overridden by call server settings. For more information, contact your system administrator.

Static Forwarding

To forward all incoming calls to another party:

1. From the idle display, press the **Forward** soft key.

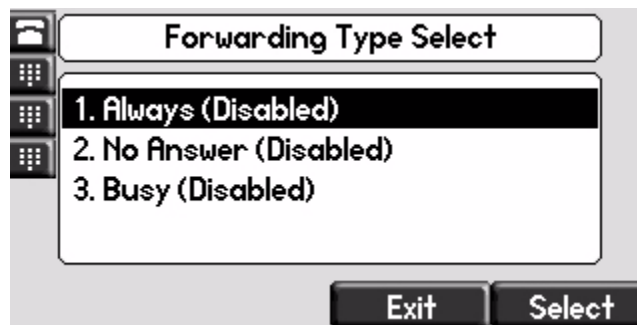

2. (Optional.) If multiple lines are configured on your phone, select the line to forward from the list using \uparrow and \downarrow .
3. Using \uparrow and \downarrow , select the forwarding type you want to change, and then press the **Select** soft key. The options are:
 - **Always** – To forward all incoming calls
 - **No Answer** – To forward unanswered incoming calls
 - **Busy** – To forward calls that arrive when you are already in a call
4. Depending on your selection:

- a If you selected **Always**, enter a number to forward all future incoming calls to.

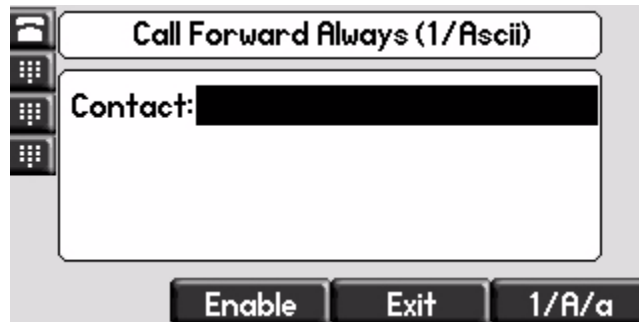

- b If you selected **No Answer**, enter a number to forward all unanswered incoming calls to and how many rings to wait before forwarding (one ring is approximately six seconds). A value of 2 is recommended.

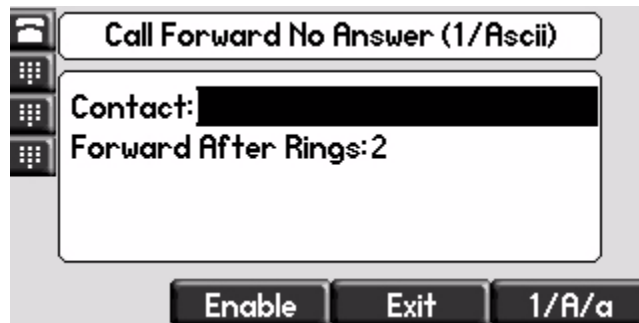

- c If you selected **Busy**, enter a number to forward all future incoming calls to when you are already in another call.

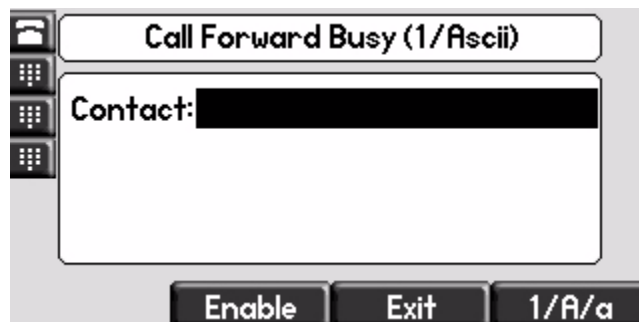





Note

You can also enter the SIP URL or IP address. For more information on using a SIP URL or IP address, refer to [Placing Calls](#) on page 3-2

5. Select the **Enable** soft key to confirm call forwarding.

A moving arrow appears on the line label to confirm call forwarding is enabled.

To disable call forwarding:

1. From the idle display, press the **Forward** soft key.
2. (Optional.) If multiple lines are configured on your phone, select the line to forward from the list using  and .
3. Using  and , select the forwarding type you want to change and then press the **Select** soft key.
4. Press the **Disable** soft key.

The idle display returns and the regular icon appears as the line indicator.

Dynamic Forwarding**To forward an incoming call to another party:**

1. When the phone rings, press the **Forward** soft key.
2. Enter a number to forward the incoming call to.
3. Press the **Enable** soft key.

The incoming call is forwarded to the other party. If call forwarding is disabled, all future calls will not be forwarded and forwarding will remain disabled.

Enabling Do Not Disturb

To prevent the phone ringing (from incoming calls), you can select Do Not Disturb.

Note

This feature is local to the phone, and may be overridden by call server settings. For more information, contact your system administrator.

To enable Do Not Disturb:

>> Press **Do Not Disturb**.

A flashing icon and text on the graphic display indicate that Do Not Disturb is enabled.

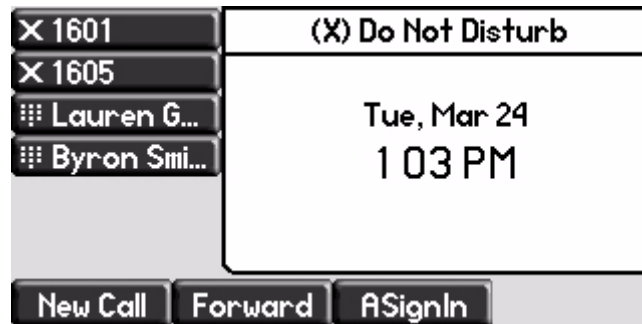

Calls received while Do Not Disturb is enabled are logged in the Missed Calls list unless configured to be forwarded to another party by your system administrator.

To disable Do Not Disturb:

>> Press **Do Not Disturb** again.

Multiple Lines and Do Not Disturb

If multiple lines are configured on your phone, Do Not Disturb can be set on a line-by-line basis from the menu using **Up** and **Down**. For more information, contact your system administrator. When Do Not Disturb is enabled for a particular line, a flashing "X" displays beside the line indicator.

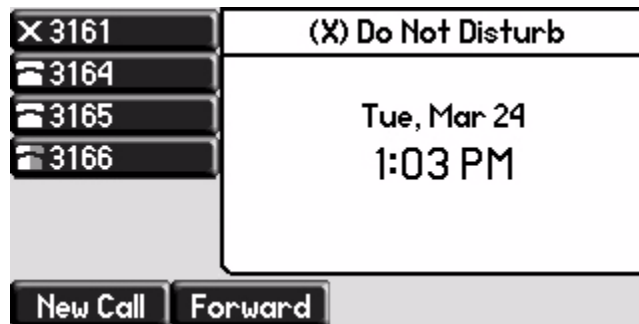

Assigning Speed Dial Keys

You can associate contacts with Line Keys for single touch dialing of frequently used numbers. Speed Dial entries are consecutively placed next to assigned Line Keys on the phone. When a new entry is added to the Contact Directory, it is automatically assigned the next available speed dial index and the next available line key.

In the figure below, the phone has one line key, and three available speed dial keys (assigned to Byron, Lauren, and Andrew). To dial Byron, Lauren, or Andrew, press the associated line key.

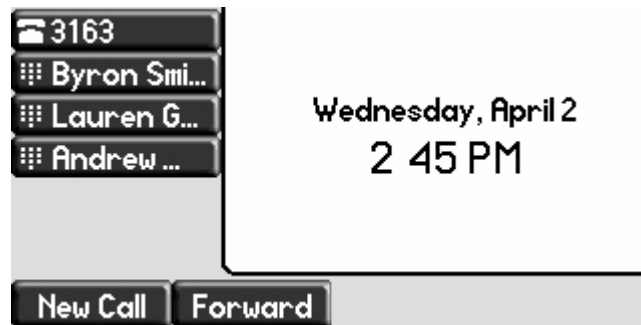



Note

To quickly access a list of speed dial index numbers, press the **Up Arrow** key from the idle screen. To speed dial a contact, press the **Up Arrow** key followed by the contact's speed dial index. For example, if Joan's speed dial index is 55, pressing the **Up Arrow** key followed by **55** will place a call to Joan.

To add or edit a speed dial index for an existing contact:

1. Press **Directories**.
2. Select **Contact Directory**.
3. Use **▲** and **▼** to highlight the contact.
You can also use the * key to page up and the # key to page down.
4. Press the **Edit** soft key.



5. Do one of the following:
 - Enter the next available speed dial index.
 - Delete the existing speed dial index by using  followed by , and then enter a new speed dial index.
- Valid speed dial index values are from 1 to 9999. If you enter a speed dial index that already, “Speed dial index already exists” appears. If you enter an invalid value, “Speed dial index invalid” appears.
6. Press the **Save** or **Cancel** soft keys to accept or cancel changes.
 7. Press  to return to the idle display.

To assign a new speed dial key:

1. Press and hold an unassigned .

A new empty entry in the contact directory is automatically opened allowing contact information to be added.
2. Press the **More** soft key, and then press the **Add** soft key.
3. (Optional.) Enter contact information.

Use the **1/A/a** soft key to select between numeric and upper/lower case alphanumeric modes.

Use the **Encoding** soft key to access special characters in other languages.
4. Enter a contact number.

The number must be unique (not already in the directory).
5. Change the Speed Dial Index field.

The index can be any value between the next available index value and the maximum (value of 9999).



Polycom recommends that you assign speed dial index values consecutively. For example, if you assign the third Line Key to the speed dial index value “2”, assign the fourth Line Key to the speed dial index value “3”.

6. Press the **Save** or **Cancel** soft keys to accept or cancel changes.
7. Press  to return to the idle display.

Using Voice Mail

Note

Voice mail is an optional feature configured on the call server and may not be supported on your particular system. For more information, contact your system administrator.

Screen options may vary with your application. Voice mail may be accessible with a single key press. Contact your system administrator about this option.

You can access voice mail messages from your phone. Your voice mail is saved in a centralized location.

Your phone indicates the presence of new voice mail messages by a flashing Message Waiting Indicator LED on the front of the phone and a visual notification on the screen. If your phone has multiple lines, an individual line indicator icon indicates voice mail messages on that line.

A stutter dial tone in place of normal dial tone indicates that one or more voice messages are waiting at the message center.

To listen to voice messages:

1. Press  .

If multiple lines are configured on your phone, select the line to retrieve messages from.

2. Follow voice or visual prompts on the screen to retrieve your messages.

Using the Advanced Features of Your Phone

This chapter provides operating instructions for the advanced features of the SoundPoint IP 670 desktop phone. The topics include:

- [Using Multiple Call Appearances](#)
- [Using Text Messaging](#)
- [Using Buddy Lists](#)
- [Recording a Call](#)
- [Playing Back a Recorded Call](#)
- [Restarting Your Phone](#)

To customize your phone, refer to [Customizing Your Phone](#) on page 2-1. To read about the phone's basic features, refer to [Using the Basic Features of Your Phone](#) on page 3-1. To add a SoundPoint IP Color Expansion Module to your SoundPoint IP 670 phone, refer to [Using the SoundPoint IP Color Expansion Module](#) on page 5-1.

If you require additional information or assistance with your new phone, contact your system administrator.

Using Multiple Call Appearances

When multiple call appearances is set up, you can see information for more than one call at one time. For example, if you have an active call, you can see information for an incoming call as well.

For example, the following figure shows an active call with Greg Slowski on line 6721.

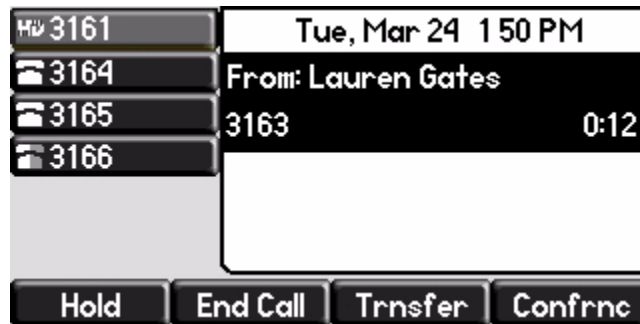

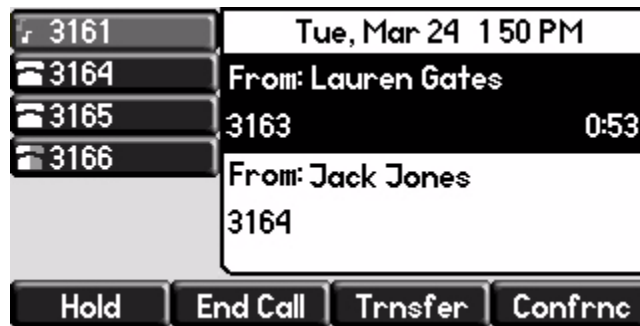

The following figure shows an incoming call from 1-800-765-9266 on the same line.



To answer an incoming call when configured for multiple call appearances:

>> Do one of the following:

- Press  or the **Hold** soft key to place the original call on hold.
- Press  to access the new call.

Answer the incoming call.

This original call is placed on hold and the incoming call becomes the active call.



Your phone can display two call appearances at one time. If more than two calls are taking place on the same line, a counter displays on the display. Use the down arrow to access additional calls, or “appearances”.

To place an additional call on the same line, place the active call on hold, and then press the **New Call** soft key.

Using Text Messaging

You can send and receive text messages using your phone. Text messaging is supported in real-time. Your phone indicates text messages by a flashing Message Waiting Indicator LED on the front of the phone and, optionally, a visual notification on the graphic display.

Note

The text messaging feature is an optional feature and may not be supported on your particular system. If it is supported, screen options may vary with your application. Text messaging may be accessible with a single key press. For more information, contact your system administrator.

To read text messages:

1. Do one of the following steps:



– Press  .

Select **Instant Messages**.

– Press  .

Select **Features > Messages > Instant Messages**.

– Press the **InstMsg** soft key.

2. (Optional.) If multiple lines are configured on your phone, use  and  to select the line to retrieve messages from.

The first message received displays last.

3. (Optional.) Do one of the following:

– Press the **Next** or **Prev** soft keys to cycle through messages in order.

– Press the **More** soft key to access the **Delete**, **Reply**, and **New** soft keys.

4. Press  to return to the idle display.

To send a text message:

1. Do one of the following:

- Press  .



Select **Instant Messages**.

Note

Screen options may vary with your application. Text messaging may be accessible with a single key press. Contact your system administrator about this option.

- Press  .

Select **Features > Messages > Instant Messages**.

2. (Optional.) If multiple lines are configured on your phone, use  and  to select the line to retrieve messages from.

3. Press the **New** soft key.

4. Enter the number.

Use the **1/A/a** soft key to alternate between numeric and upper/lower case alphanumeric modes.

Note

You can also enter the SIP URL or IP address. For more information on using a SIP URL or IP address, refer to the instructions for using the handset in [Placing Calls](#) on page 3-2.

5. Press the **Ok** soft key.

6. Do one of the following:

- To choose from various pre-scripted short messages, press the **Select** soft key.

- To compose a custom message, press the **Edit** soft key.

Use dial pad keys to cycle through the character set. Use keys 1, *, 0, and # to select special characters.

7. Press the **Send** soft key.

8. Press  to return to the idle display.

Using Buddy Lists

A buddy list is a list of users/devices whose status or “presence” you can monitor. Users update their presence setting (for example, “Be right back”, “Busy”, or “Out to lunch”), and you can view their status in real-time from your phone.

Your phone can “watch” the status of up to eight other phones or 48 buddies. These other phones form your “buddy list”. Your phone displays the status of your buddies in real time. Your phone can be “watched” by up to eight other phones.

If your SoundPoint IP 670 phone is configured to work with Microsoft Live Communications Server 2005, the behavior of the presence setting and buddy lists is different. For more information, contact your system administrator.

Presence Settings

To view and change your presence settings:



1. Do one of the following:

- Press  .

Select **Features** > **Presence** > **MyStatus**.

- Press the **MyStat** soft key.



2. Use  or  to scroll through the list, and then press the **Select** soft key to select your new status.

The phones watching your status will now display your new status.







Presence information will also be sent to watching phones when you go off-hook or enable Do Not Disturb.

Managing Buddies





Note

The instructions in this section do not apply if your call server is Microsoft Live Communications Server 2005. In that case, refer to the following section, [Integrating With Microsoft Live Communications Server 2005](#).

To add or delete a contact from your buddy list:

1. Press .
2. Select **Contact Directory**.
3. Use  and  to highlight the contact.
You can also use the * key to page up and the # key to page down.
4. Press the **Edit** soft key.
5. Scroll to the Watch Buddy field.
6. Use  and  to enable or disable the Watch Buddy field.
When Watch Buddy is enabled, the contact is added to your buddy list.
When Watch Buddy is disabled, the contact is removed from your buddy list.
The default for Watch Buddy is Disabled.
7. Press the **Save** or **Cancel** soft keys to accept or cancel changes.
8. Press  to return to the idle display.

To block or unblock a contact from your buddy list:

1. Press .
2. Select **Contact Directory**.
3. Use  and  to highlight the contact.
You can also use the * key to page up and the # key to page down.
4. Press the **Edit** soft key.
5. Scroll down to the Block Buddy field.
6. Use  and  to enable or disable the Block Buddy field.
When Block Buddy is enabled, the contact cannot watch your phone.
When Block Buddy is disabled, the contact can watch your phone.
The default for Block Buddy is Disabled.
7. Press the **Save** or **Cancel** soft keys to accept or cancel changes.

8. Press  to return to the idle display.

Integrating With Microsoft Live Communications Server 2005



Your system administrator can configure your phone to work with Microsoft Live Communications Server 2005 and communicate with others using Microsoft Office Communicator and Windows Messenger. From your phone, you can invite, join, control, and monitor integrated multipoint audio and video conferences.

Any contact you add through your buddy list will appear as a contact in Microsoft Office Communicator and Windows Messenger. Any contact you add as a contact in Microsoft Office Communicator and Windows Messenger will appear in your buddy list.



To view and change your presence, refer to [Presence Settings](#) on page 4-5.

For more information, contact your system administrator.

To add a contact to your buddy list:

1. Press .
2. Select **Features > Presence > Buddy Status**.
3. Press the **More** soft key.
4. Press the **Add** soft key.
5. Enter the number of the contact.
6. Press the **Submit** soft key.
7. Press  to return to the idle display.

To view and change your privacy list:

1. Press .
2. Select **Features > Presence > Buddy Status > Privacy List**.
3. Use  and  to scroll through the list to find the contact.
4. Press the **Edit** soft key.
5. Scroll down to the Access field.

6. Use (◀) and (▶) to enable or disable the Access field.

When Access is enabled, you allow the contact to see your presence. When Access is disabled, you prevent the contact from seeing your presence.

The default for Access is Disabled.

7. Press  to return to the idle display.

For more information on contacting buddies, refer to [Placing Calls](#) on page 3-2 or the Microsoft Office Communicator and Windows Messenger documentation.

Recording a Call

Note

Call Recording is an optional feature and may not be supported on your particular system. For more information, contact your system administrator.

If the Call Recording and Playback feature is available and you plug a removable USB flash drive into the USB port on your SoundPoint IP 670, you can record active calls on your phone. Recordings are stored as **.wav** files on the USB flash drive. You can record up to 4 hours in one file. The approximate time remaining for recording (the free space on the USB flash drive) is shown on the graphic display.

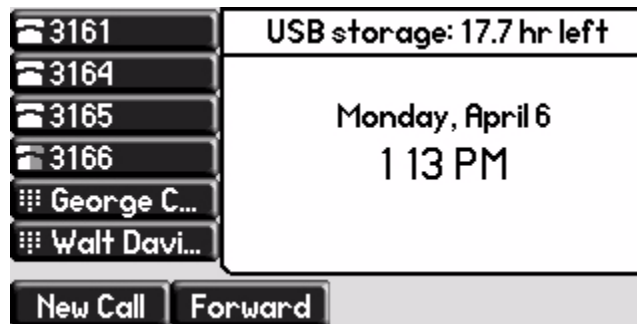

The **Record** soft key controls recording and is available:

- When there are one or more calls connected to your phone (you may need to press the **More** soft key to see it)
- During an active call
- When calls are on hold
- During a consultative transfer or conference call

The **Record** soft key is not available:

- When there are no connected calls on your phone
- When you place a new call (to transfer or to conference)
- When the phone prompts you to answer an incoming call

If you put an active call on hold, recording pauses. Recording continues if the called party puts you on hold. Recording stops if all active calls end, no matter who ends the calls.

If you press  while recording, only the called parties are recorded.

Tones and indications (for example, dialing of digits or ringing from another party's phone) that occur before a call connects are not recorded. Local tones and indications (for example, DTMF tones when dialing) are not recorded. However, tones from another party's phone may be recorded.

You can start, pause, resume, and stop recording through the use of soft keys. All active calls that occur on your phone between the time you press the **Start** soft key and the **Stop** soft key are recorded, alternating in the same **.wav** file. For example, you place a call to party A and, after they answer, you start recording on October 4, 2007 at 11:22am. While speaking with party A, you get an incoming call. You put party A on hold and speak with party B. When you finish speaking with party B, you return to speaking with party A. While speaking with party A again, you get another incoming call. You put party A on hold and speak with party C. When you finish speaking with party C, you return to speaking with party A. You end your call with party A and recording stops. Your conversations with parties A, B, and C are all recorded in the same **.wav** file as follows:

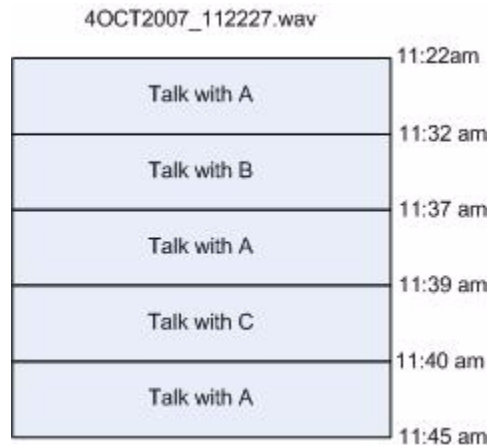

If there is insufficient free space on the USB flash drive when you press the **Start** soft key, recording does not start and the message "USB device is full. Recording cancelled." appears.

If the USB flash drive becomes full during recording, recording stops and the message "USB device is full. Recording stopped." appears.

If you remove the USB flash drive during recording, recording stops and the message “USB device removed unsafely. Recording cancelled.” appears.



Polycom recommends that you do not remove the USB flash drive while recording. The file being recorded at that time will be incomplete and cannot be played back later. There is a small probability that the USB flash drive itself may be damaged by this action.

Note

You may be required by federal, state, and/or local laws to notify some or all called parties when you are recording (either one-party or all-party consent). Specific information about US state requirements can be found at <http://www.rcfp.org/taping/>. Telephone call recording regulations in other countries vary widely. Polycom recommends checking with the local government's telecommunications authority and government legal agencies.

Other information that may useful can be found at:

- <http://www.fcc.gov/cgb/consumerfacts/recordcalls.html>
- <http://www.privacyrights.org/fs/fs9-wrtp.htm>

This section includes information on:

- [Recording Calls](#)
- [Recording Conferences](#)
- [Pausing and Resuming Recording](#)

To playback recorded calls, refer to [Playing Back a Recorded Call](#) on page 4-13.

Recording Calls

To record a call:

1. During a call, press the **More** soft key.



2. Press the **Record** soft key.



3. To start recording, press the **Start** soft key.



"*R*" appears on the graphic display while the phone records.

If you press the **Back** soft key, you can access the top-level soft keys (for example, **Hold**, **EndCall**, **Trnsfer**, and **Confrnc**). You must navigate back (using the **More** and **Record** soft keys) to again access the **Stop** and **Pause** soft keys.

4. Stop recording in one of the following ways:
 - Press the **Stop** soft key.
 - Hang-up or end the active call.

Recording Conferences

You can record conference calls in the same way as other calls with the following exceptions:

- All parties in a conference call are recorded. If one of the conference parties presses , they are not recorded.
- When all parties in a conference call are put on hold together, recording is paused. You can place or answer other calls, which will be recorded in the same file. When the conference call is resumed, recording of the conference resumes.

Pausing and Resuming Recording

You can pause recording by pressing the **Pause** soft key. When you press the **Resume** soft key, recording continues with the same **.wav** file.

To pause a recording:

>> Press the **Pause** soft key.

“*P*” appears when you pause recording.



To resume a recording:

>> Press the **Resume** soft key.

“*R*” appears when you restart recording.



Playing Back a Recorded Call

Note

Call Playback is an optional feature and may not be supported on your particular system. For more information, contact your system administrator.



If the Call Recording and Playback feature is available, and a removable USB flash drive is plugged into the USB port of your SoundPoint IP 670, you can play back calls that you recorded on your phone.



You can browse the recorded files, stored as **.wav** files on the USB flash drive. You can also open, rename, and delete the recorded files. If there are no supported **.wav** files on the USB flash drive, the message “Unsupported wav file format.” appears on the graphic display.

You can play, pause, resume, and stop recording through the use of soft keys.

Playback occurs in real time. Pressing  adjusts the volume of the receiver audio during playback.

Playback stops if you press the **Exit** soft key, , ,

, or .

If the handset is off-hook when you press the **Play** soft key, you will hear audio through the handset. If the handset is on-hook when you press the **Play** soft key, you will hear audio through the speaker. If the handset is on-hook, pressing  is the same as pressing the **Play** soft key, and pressing  again is the same as pressing the **Exit** soft key. If you lift the handset while you are listening through the speaker, you will now hear the audio through the handset.

You cannot start playback while a call is in progress or if you have placed a call. The message “Active call. Action aborted.” appears in either case. If all calls are on hold, you can start playback. If you press  on the selected call or the particular line key for the held call, playback stops and the call resumes.

You cannot place a call while playback is in progress using the dial pad. However, you can place a call using a speed dial key or line key. You can answer calls while playback is in progress (refer to [Answering a Call While Playing Back Recorded Calls](#) on page 4-16).

You can also playback recorded files on other devices, such as a Windows® or Apple® based computer using an application capable of playing **.wav** files.

If an error occurs while playback is in progress, playback stops. If you remove the USB flash drive during recording, recording stops and the message “USB device removed unsafely. Playback cancelled.” appears.



Polycom recommends that you do not remove the USB flash drive while playing back files. There is a small probability that the USB flash drive itself may be damaged by this action.

This section includes information on:

- [Browsing Recorded Calls](#)
- [Playing Back Recorded Calls](#)
- [Answering a Call While Playing Back Recorded Calls](#)

Browsing Recorded Calls

To browse the recorded files:

1. Press .
2. Select **Features > USB Device... > Browse Recordings...**

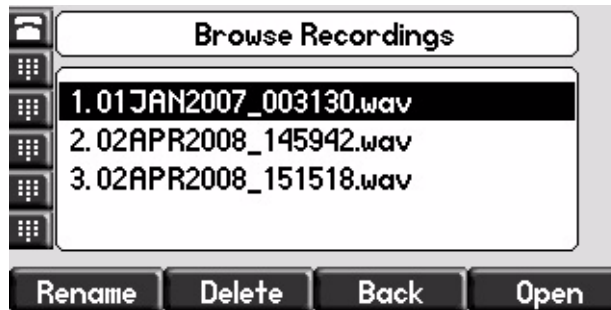



You can rename, delete, or play back the selected **.wav** file by pressing the **Rename**, **Delete**, or **Open** soft keys.

3. Press  to return to the idle display.

Playing Back Recorded Calls

To playback a call:

1. Press .
2. Select **Features > USB Device... > Browse Recordings...**

3. Select the file that you want to play back using  and , and then press the **Open** soft key.

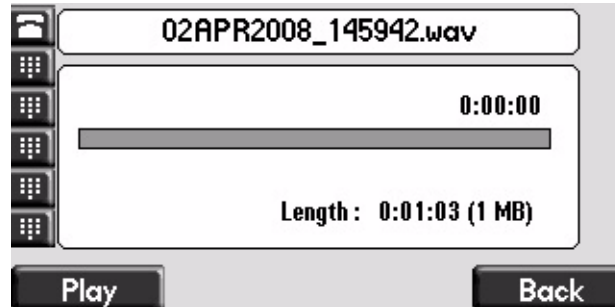

The filename you selected appears on the graphic display. The length of the file (in hours, minutes, and seconds) and the size of the file also appear.

4. Press the **Play** soft key.

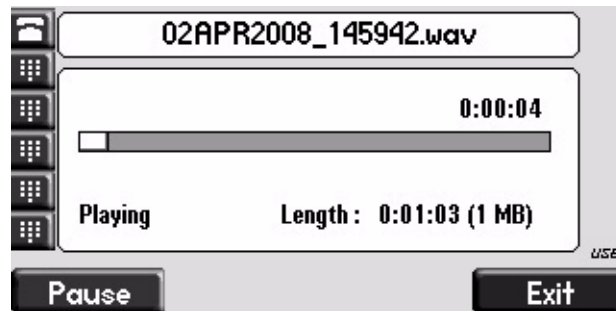

“Playing” appears on the graphic display. The position indicator (in hours, minutes, and seconds) above the progress bar changes as the file plays back in real time.

(Optional.) Press the **Pause** soft key to pause the file playback.

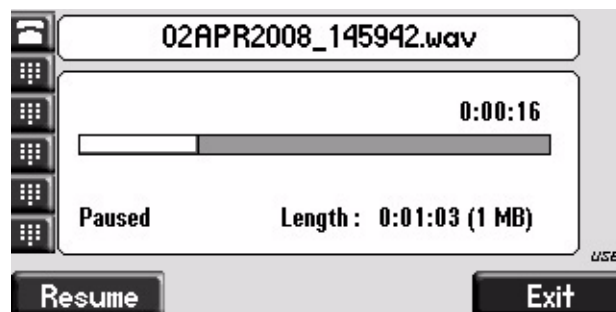

(Optional.) Press the Resume soft key to resume playback of the file.

5. Press the **Exit** soft key to stop playing back the file.
To play back the file from the start, refer to step 3.



6. Press  to return to the idle display.

Answering a Call While Playing Back Recorded Calls

You are playing back a file and an incoming call arrives. Playback pauses and the phone rings.

To answer a call using the speakerphone:

>> Do one of the following:

- Press .
- If you were listening to the file through the phone's speaker, press the line key for the incoming call.
- If you were listening to the file through the phone's speaker, press , and then press the **Answer** soft key.

When the call ends, the idle display appears.

To answer a call using the handset:



>> Do one of the following:

- Lift the handset.
If you were listening to the file through the handset, hang up the handset, and then pick it up again.
- If you were listening to the file through the handset, press the line key for the incoming call.
- If you were listening to the file through the handset, press , and then press the **Answer** soft key.

When the call ends, the idle display appears.

To answer a call using the headset:

>> Do one of the following:

- Press .
- If you were listening to the file through the headset, press the line key for the incoming call.
- If you were listening to the file through the headset, press , and then press the **Answer** soft key.

Note

If you are using a digital headset with an answer button or an analog headset with an electronic switch, use those to answer the incoming call.

When the call ends, the idle display appears.

If you decide to reject the incoming call, press the **Resume** soft key, and playback will resume. For more information, refer to [Playing Back Recorded Calls](#) on page 4-14.

Restarting Your Phone

Periodically, you may need to restart your phone so your phone can accept a new configuration.

Note

If your phone malfunctions, you may be able to restore normal operation without restarting it. Before you restart your phone, contact your system administrator.

Note

Call lists are automatically cleared when you restart the phone.

To restart the phone:

1. Press  .
2. Select **Settings > Basic > Restart Phone**.
“Are you sure?” appears on the graphic display.
3. If you still want to restart your phone, press the **Yes** soft key.

The restart process begins. The process ends when the idle display appears.

Using the SoundPoint IP Color Expansion Module

This chapter provides basic installation and operating instructions and information for obtaining the best performance with the SoundPoint IP Color Expansion Module.

The SoundPoint IP Color Expansion Module enhances the user interface of the SoundPoint IP 670 desktop phone with a high-resolution graphic display and 14 Line Keys that you can automatically configure as a line, call appearance, speed dial, or busy lamp field. You can connect up to three SoundPoint IP Color Expansion Modules to the SoundPoint IP 670 phone to provide a productivity-enhancing solution if you manage and monitor multiple simultaneous telephone calls on a daily basis.

This chapter contains:

- [Parts List](#)
- [Connecting the SoundPoint IP Color Expansion Module](#)
- [Features of the SoundPoint IP Color Expansion Module](#)

This chapter contains instructions on:

- [Adjusting the Display Contrast](#)
- [Adjusting the Backlight](#)
- [Placing Calls](#)
- [Answering Calls](#)
- [Assigning Speed Dial Keys](#)
- [Using the Busy Lamp Field](#)

To customize your phone, refer to [Customizing Your Phone](#) on page 2-1. To read about the phone's basic features, refer to [Using the Basic Features of Your Phone](#) on page 3-1. To read about the phone's advanced features, refer to [Using the Advanced Features of Your Phone](#) on page 4-1.

If you require additional information or assistance with the SoundPoint IP ColorExpansion Module, contact your system administrator.

Parts List

The following components are included in your SoundPoint IP Color Expansion Module package:

- Polycom SoundPoint IP Color Expansion Module

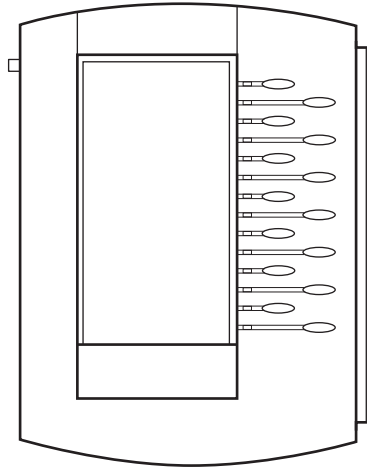

- Base stand

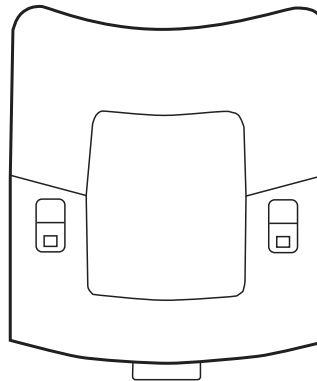

Check this list before installation to ensure that you have received each item. If you are missing any items, contact your system administrator.

Connecting the SoundPoint IP Color Expansion Module

This section describes how to attach the SoundPoint IP Color Expansion Module to your phone. You can attach up to three SoundPoint IP Color Expansion Modules.

To connect a SoundPoint IP Color Expansion Module to your phone:

1. Remove the rubber plug from the SoundPoint IP 670 phone or the SoundPoint IP Color Expansion Module.

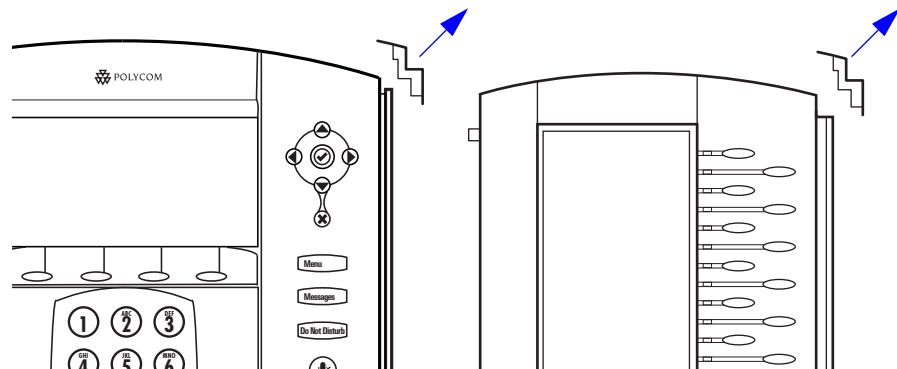

2. Align the SoundPoint IP Color Expansion Module at the top of the groove lines on the SoundPoint IP 670 phone and slide it downwards until it clicks into position.

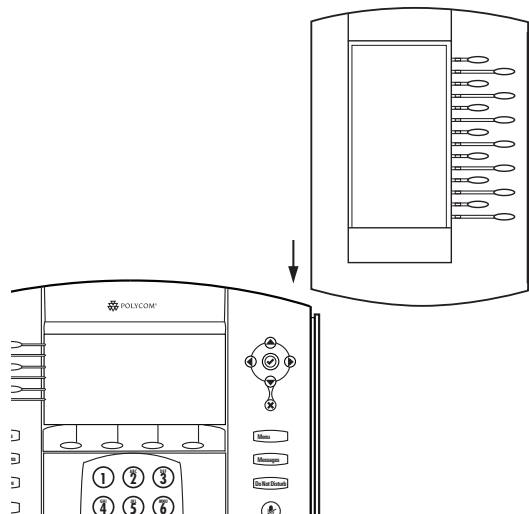

3. Connect the base stand by aligning the two protrusions on the stand to the holes on the back of the Color Expansion Module and snap it into place.

For each SoundPoint IP Color Expansion Module that you want to add, repeat steps 1 to 3.

Features of the SoundPoint IP Color Expansion Module

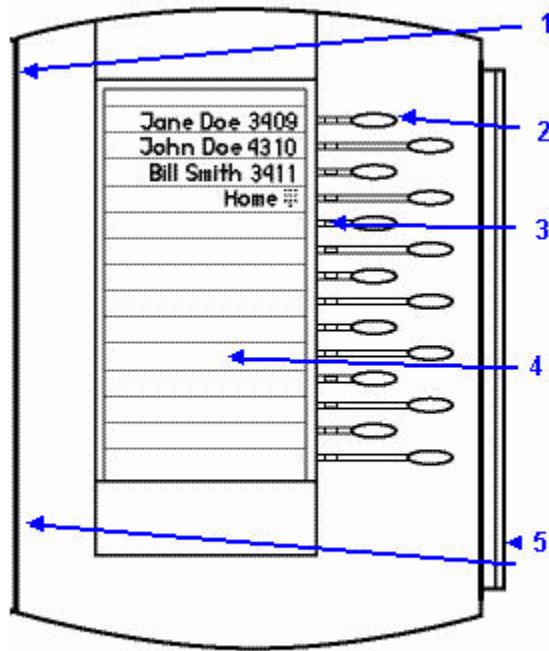

The features of the SoundPoint IP Color Expansion Module are:

	Item	Description
1	Power Contact	Not visible when you connect the SoundPoint IP Color Expansion Module to the phone. Power automatically transfers from the host phone to the SoundPoint IP Color Expansion Module(s) upon connection. You can plug in and unplug the units at any time
2	Line/Speed Dial Keys	Use these keys to activate up to 47 lines or speed dials that can be assigned to your phone.

	Item	Description
3	Line Indicators	Individual multi-color LEDs display the dynamic call state and remote user status (busy lamp field [BLF] and presence). The mapping is: Solid green—An active call is in progress. Fast flashing green—There is an incoming (ringing) call. Flashing green—Another party has put you on hold. Flashing red—The call is on hold. Solid red—The line is busy remotely (shared lines).
4	Graphic Display	Shows information about lines or speed dials.
5	Infrared Lens	Facilitates communications to the host phone and other Expansion Modules.

Adjusting the Display Contrast

To adjust the display contrast on a SoundPoint IP ColorExpansion Module, refer to [Changing the Display Contrast](#) on page 2-3.

Note

Once you have saved your new display contrast setting, there may be some delay before the Expansion Module display returns to the selected background.

Adjusting the Backlight

To adjust the backlight on a SoundPoint IP Color Expansion Module, refer to [Changing the Backlight Intensity](#) on page 2-4.

Placing Calls

When you connect a SoundPoint IP Color Expansion Module to your phone, you can place a call using one of the Line Keys.

To place a call using a SoundPoint IP Color Expansion Module Line Key:

>> Press the assigned  directly opposite the number on the graphic display.

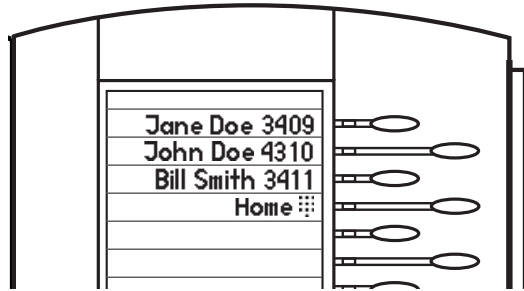

For more information on placing a call, refer to [Placing Calls](#) on page 3-2.

Answering Calls

When you connect a SoundPoint IP Color Expansion Module to your phone, you can answer a call using one of the Line Keys.

To answer a call using a SoundPoint IP Color Expansion Module Line Key:

>> Press the assigned  directly opposite the line with the fast flashing green LED indicator.

For more information on answering a call, refer to [Answering Calls](#) on page 3-4.

Assigning Speed Dial Keys

You can associate contacts with Line Keys on the SoundPoint IP Color Expansion Module for single touch dialing of frequently used numbers. Speed Dial entries are consecutively placed next to assigned Line Keys.

For example, in the figure below, press the fourth Line Key to dial home.

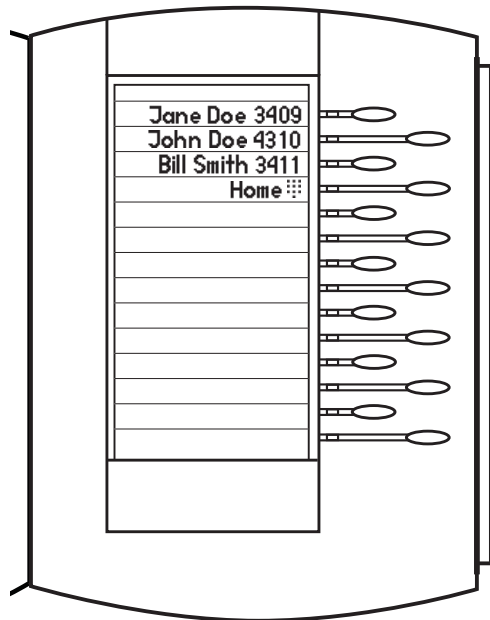

To assign a new speed dial key:

1. Press and hold an unassigned .

A new empty entry in the contact directory is automatically opened allowing contact information to be added.
2. Press the **More** soft key.
3. Press the **Add** soft key.
4. (Optional.) Enter first and/or last name of the contact from the keypad.

Use the **1/A/a** soft key to select between numeric and upper/lower case alphanumeric modes.

Use the **Encoding** soft key to access special characters in other languages.
5. Enter a contact number.

The number must be unique (not already in the directory).
6. Change the Speed Dial Index field.

Valid speed dial index values are from 1 to 9999. If you enter a speed dial index that already, "Speed dial index already exists" appears. If you enter an invalid value, "Speed dial index invalid" appears.



Polycom recommends that you assign speed dial index values consecutively. For example, if you assign the third Line Key to the speed dial index value "2", assign the fourth Line Key to the speed dial index value "3".

7. Press the **Save** or **Cancel** soft keys to accept or cancel changes.
8. Press  to return to the idle display.

For more information on assigning speed dial keys, refer to [Assigning Speed Dial Keys](#) on page 3-23.

Using the Busy Lamp Field

The busy lamp field (BLF) feature allows you to monitor the hook status and presence information of other users. You monitor status information through the BLF LED indicators and display on the phone with the attached SoundPoint IP Color Expansion Module. For more information, contact your system administrator.

The following figure shows the busy status of other users (for example, Louis, Jack, Don, William, Milton, and Z are busy on the phone):

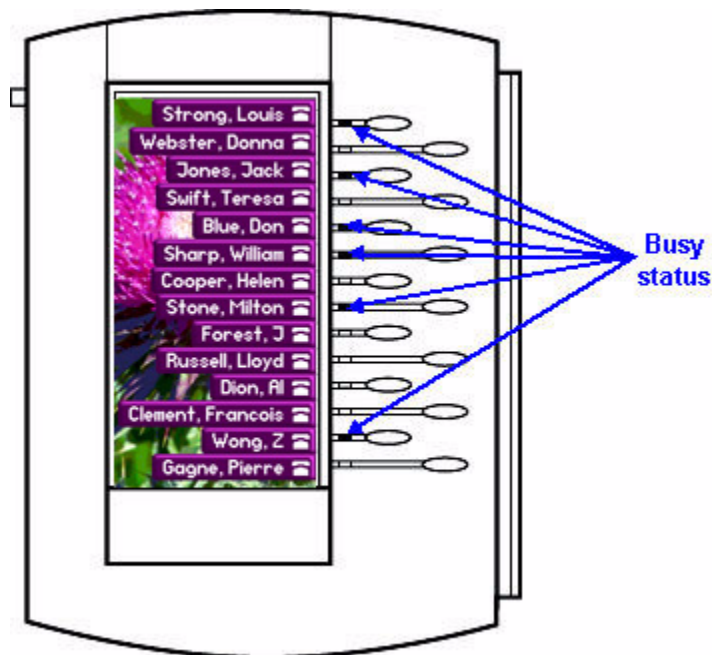

For more information, refer to “Quick Tip 37381: Enhanced BLF” at http://www.polycom.com/usa/en/support/voice/soundpoint_ip/VoIP_Technical_Bulletins_pub.html.

Troubleshooting Your Phone

This chapter contains general troubleshooting information to help you solve any problems you might encounter when you use your SoundPoint IP 670 phone. The tables in this chapter list possible trouble symptoms, the likely causes of these problems, and the recommended corrective actions to take.

- [Power and Startup](#)
- [Controls](#)
- [Access to Screens and Systems](#)
- [Calling](#)
- [Displays](#)
- [Audio](#)
- [Productivity Suite](#)

To obtain more detailed troubleshooting information, you can access certain menus on your phone that test your phone hardware. For more information, see [Testing Phone Hardware](#) on page 6-9.

If you require additional assistance, contact your system administrator.

Power and Startup

Symptom	Problem	Corrective Action
There are power issues.	The SoundPoint IP 670 phone has no power.	<p>Do one of the following:</p> <ul style="list-style-type: none">• Verify that no lights appear on the phone when it is powered up.• Check if the phone is properly plugged into a functional AC outlet.• Make sure that the phone isn't plugged into a plug controlled by a light switch that is off.• If the phone is plugged into a power strip, try plugging it directly into a wall outlet instead.• Try the phone in another room where the electricity is known to be working on a particular outlet.• If using PoE, the power supply voltage may be too high or too low.

Controls

Symptom	Problem	Corrective Action
<p>The dial pad does not work.</p>	<p>The dial pad on the SoundPoint IP 670 phone does not respond.</p>	<p>Do one of the following:</p> <ul style="list-style-type: none"> • Check for a response from other feature keys or from the dial pad. • Place a call to the phone from a known working telephone. Check for display updates. • Check if the LAN port is active or inactive. Press the Menu key, and then select Status > Network > Ethernet. From the Ethernet page, scroll to the LAN port field and verify that it is active. • Check the termination at the switch or hub end of the network LAN cable. Ensure that the switch/hub port connected to the telephone is operational (if not accessible, contact your system administrator). • Before restarting your phone, contact your system administrator. Your system administrator may want to troubleshoot your phone in more detail before restarting the phone and losing current status information.

Access to Screens and Systems

Symptom	Problem	Corrective Action
There is no response when you press a feature key.	The SoundPoint IP 670 phone is not in an active state.	<p>Do one of the following:</p> <ul style="list-style-type: none"> • Press the keys more slowly. • Check with your system administrator to see if the key has been mapped to a different function or is disabled. • Place a call to the phone to check that inbound call display and ringing is normal. If successful, try to press feature keys within the call to access the Main Menu, for example. • To confirm that the line is active, press the Menu key, and then select Status > Lines > Line Information. From the Line Information page, verify that your phone line is registered. • Reboot the phone to attempt re-registration to the call server. Contact your system administrator.
The screen shows “Network Link is Down”.	The LAN cable is not properly connected.	<p>Do one of the following:</p> <ul style="list-style-type: none"> • Check termination at the switch or hub (furthest end of the cable from the phone). • Check that the switch or hub is operational (flashing link/status lights) or contact your system administrator. • Check if the LAN port is active or inactive. Press the Menu key, and then select Status > Network > Ethernet. From the Ethernet page, scroll to the LAN port field and verify that it is active. • Reboot the phone to attempt re-registration to the call server. Contact your system administrator.

Calling

Symptom	Problem	Corrective Action
There is no dial tone.	Power is not correctly applied to the SoundPoint IP 670 phone.	Do one of the following: <ul style="list-style-type: none"> • Check that the screen is illuminated. • Make sure the LAN cable is inserted properly at the back of the phone (try unplugging and re-inserting the cable). • If using in-line powering, have your system administrator check that the switch is supplying power to the phone.
	Dial tone is not present on one of the audio modes.	Do one of the following: <ul style="list-style-type: none"> • Switch between Handset, Headset (if present) or Hands-Free Speakerphone to see if the dial tone is present for one of audio modes. • If the dial tone exists on another audio mode, connect a different handset or headset to isolate the problem.
	The phone is not registered.	Contact your system administrator.
The phone does not ring.	Ring setting or volume is low.	Do one of the following: <ul style="list-style-type: none"> • Adjust the ringing level from the front panel using the volume up/down keys. • Check status of Handset, Headset (if connected), and Hands-Free Speakerphone.
	Outbound or inbound calling is unsuccessful.	Do one of the following: <ul style="list-style-type: none"> • Place a call to the phone under investigation. Check that the screen indicates incoming call information. • Lift the handset. Ensure the dial tone is present and place a call to another extension or number. Check that the screen changes in response.

Symptom	Problem	Corrective Action
	You turned off the ringer.	Do one of the following: <ul style="list-style-type: none"> • During an incoming call, lift the handset, press the Speakerphone key, or press the Headset key to obtain a dial tone. • Press the ringing Line Key or the Answer soft key to answer the call.
"Service Unavailable" appears on the screen.	The user pressed the New Call soft key, dialed a number with the handset on-hook, or attempted to make a call from the contact directory when the phone was not registered.	Check with your system administrator to see when your phone will be registered.
The line icon shows an unregistered line icon.	The phone line is unregistered.	Contact your system administrator.

Displays

Symptom	Problem	Corrective Action
<p>There is no display. The display is incorrect. The display has bad contrast.</p>	<p>Power is not correctly applied to the SoundPoint IP 670 phone.</p>	<p>Do one of the following:</p> <ul style="list-style-type: none"> • Check that the screen is illuminated. • Make sure the LAN cable is inserted properly at the back of the phone (try unplugging and re-inserting the cable). • If using Power over Ethernet (PoE), have your system administrator check that the switch is supplying power to the phone. • Use the screen capture feature. Contact your system administrator to determine if it is enabled.
	<p>The contrast needs adjustment.</p>	<p>Do one of the following:</p> <ul style="list-style-type: none"> • Refer to Changing the Display Contrast on page 2-3. • Reboot the phone to obtain a default level of contrast. • Use the screen capture feature. Contact your system administrator to determine if it is enabled.
	<p>Outbound or inbound calling is unsuccessful.</p>	<p>Do one of the following:</p> <ul style="list-style-type: none"> • Place a call to the phone under investigation. Check that the screen indicates incoming call information. • Lift the handset. Ensure the dial tone is present and place a call to another extension or number. Check that the screen changes in response. • Use the screen capture feature. Contact your system administrator to determine if it is enabled.
<p>The display flickers.</p>	<p>A certain type of older fluorescent lighting causes the display to appear to flicker.</p>	<p>Do one of the following:</p> <ul style="list-style-type: none"> • Move the SoundPoint IP 670 SIP phone away from the lights. • Replace the lights. • Use the screen capture feature. Contact your system administrator to determine if it is enabled.

Audio

Symptom	Problem	Corrective Action
There is no audio on the headset.	The connections are not correct.	Do one of the following: <ul style="list-style-type: none"> Ensure the headset is plugged into the jack marked Headset at the rear of the phone. Ensure the headset amplifier (if present) is turned on and/or the volume is correctly adjusted. If the amplifier uses batteries, check that they are fully charged.
You are using a headset and the people you call hear echo.	There may be an issue with the echo cancellation feature of your headset.	Do the following: <ul style="list-style-type: none"> Press the Menu key, then select Settings > Basic > Preferences > Headset > Echo Cancellation. Using the arrow keys, select Enabled, and then press the Select soft key. Contact your system administrator.

Productivity Suite

Symptom	Problem	Corrective Action
You are trying to access one of the following features, but it is not available on your phone: <ul style="list-style-type: none"> Corporate Directory Recording and Playback of Audio Calls Managing Conferences 	The license is not installed on your phone or it has expired.	Do the following: <ul style="list-style-type: none"> Press the Menu key, then select Status > Licenses. Using the arrow keys, verify that the features that you want to use has a valid license. Contact your system administrator.

Testing Phone Hardware

Your system administrator may ask you to access a diagnostics menu on your phone to test your phone hardware. From the diagnostics menu, you can test your phone's microphones, speaker, handset, third-party headset (if present), keypad mappings, and LCD display. See your system administrator for instructions on how to perform these tests.

To test your phone hardware:

>> Press , and then select **Status > Diagnostics > Test Hardware > Audio Diagnostics, Keypad Diagnostics, or Display Diagnostics.**

Regulatory Notices

Service Agreements

Please contact your Polycom Authorized Reseller for information about service agreements applicable to your product.

Governing Law

This Limited Warranty and Limitation of Liability shall be governed by the laws of the State of California, U.S.A., and by the laws of the United States, excluding their conflicts of laws principles. The United Nations Convention on Contracts for the International Sale of Goods is hereby excluded in its entirety from application to this Limited Warranty and Limitation of Liability.

All rights reserved under International and Pan-American Copyright Conventions. No part of the contents of this manual may be copied, reproduced, or transmitted in any form or by any means, or translated into another language or format, in whole or part, without written consent from Polycom, Inc. Do not remove (or allow anybody else to remove) any product identification, copyright or other notices.

Limitations of Liability

LIMITATION OF LIABILITY. TO THE FULL EXTENT ALLOWED BY LAW, POLYCOM EXCLUDES FOR ITSELF AND ITS SUPPLIERS ANY LIABILITY, WHETHER BASED IN CONTRACT OR TORT (INCLUDING NEGLIGENCE), FOR INCIDENTAL, CONSEQUENTIAL, INDIRECT, SPECIAL, OR PUNITIVE DAMAGES OF ANY KIND, OR FOR LOSS OF REVENUE OR PROFITS, LOSS OF BUSINESS, LOSS OF INFORMATION OR DATA, OR OTHER FINANCIAL LOSS ARISING OUT OF OR IN CONNECTION WITH THE SALE, INSTALLATION, MAINTENANCE, USE, PERFORMANCE, FAILURE, OR INTERRUPTION OF ITS PRODUCTS, EVEN IF POLYCOM OR ITS AUTHORIZED RESELLER HAS BEEN ADVISED OF THE POSSIBILITY OF SUCH DAMAGES, AND LIMITS ITS LIABILITY TO REPAIR, REPLACEMENT, OR REFUND OF THE PURCHASE PRICE PAID, AT POLYCOM'S OPTION. THIS DISCLAIMER OF LIABILITY FOR DAMAGES WILL NOT BE AFFECTED IF ANY REMEDY PROVIDED HEREIN SHALL FAIL OF ITS ESSENTIAL PURPOSE.

Polycom Limited Warranty and Limitation Liability

LIMITED WARRANTY. Polycom warrants to the end user (“Customer”) that this product is expected to be free from defects in workmanship and materials, under normal use and service, for one year from the date of purchase from Polycom or its authorized reseller.

Polycom’s sole obligation under this express warranty is at Polycom’s option and expense, to repair the defective product or part, deliver to Customer an equivalent product or part to replace the defective item, or if neither of the two foregoing options are reasonably available, Polycom may, on its sole discretion, refund to Customer the purchase price paid for the defective product. All products that are replaced will become the property of Polycom. Replacement products or parts may be new or reconditioned.

Polycom is expected to warrant any replaced or repaired product or part for ninety (90) days from shipment, or the remainder of the initial warranty period, whichever is longer. Products returned to Polycom must be sent prepaid and packaged appropriately for safe shipment, and it is recommended that they be insured or sent by a method that provides for tracking of the package. Responsibility for loss or damage does not transfer to Polycom until the returned item is received by Polycom. The repaired or replaced item will be shipped to Customer, at Polycom’s expense, not later than thirty (30) days after Polycom receives the defective product, and Polycom will retain risk of loss or damage until the item is delivered to Customer.

The product software comes with 90-day software warranty, providing for software updates (minor releases/bug fixes). To continue to receive support, purchasing a maintenance contract is the most economical solution.

Exclusions

Polycom will not be liable under this limited warranty if its testing and examination disclose that the alleged defect or malfunction in the product does not exist or results from:

- Failure to follow Polycom’s installation, operation, or maintenance instructions.
- Unauthorized product modification or alteration.
- Unauthorized use of common carrier communication services accessed through the product.
- Abuse, misuse, negligent acts or omissions of Customer and persons under Customer’s control; or
- Acts of third parties, acts of God, accident, fire, lightening, power surges or outages, or other hazards.

Warranty Exclusive

IF A POLYCOM PRODUCT DOES NOT OPERATE AS WARRANTED ABOVE, CUSTOMER’S SOLE REMEDY FOR BREACH OF THAT WARRANTY SHALL BE REPAIR, REPLACEMENT, OR REFUND OF THE PURCHASE PRICE PAID, AT POLYCOM’S OPTION. TO THE FULL EXTENT ALLOWED BY LAW, THE FOREGOING WARRANTIES AND REMEDIES ARE EXCLUSIVE AND ARE IN LIEU OF ALL OTHER WARRANTIES, TERMS, OR CONDITIONS, EXPRESS OR IMPLIED, EITHER IN FACT OR BY OPERATION OF LAW, STATUTORY OR OTHERWISE, INCLUDING WARRANTIES, TERMS, OR CONDITIONS OF MERCHANTABILITY, FITNESS FOR A PARTICULAR PURPOSE, SATISFACTORY QUALITY, CORRESPONDENCE WITH DESCRIPTION, AND NON-INFRINGEMENT, ALL OF WHICH ARE EXPRESSLY DISCLAIMED. POLYCOM NEITHER ASSUMES NOR AUTHORIZES ANY OTHER PERSON TO ASSUME FOR IT ANY OTHER LIABILITY IN CONNECTION WITH THE SALE, INSTALLATION, MAINTENANCE OR USE OF ITS PRODUCTS.

Safety and Compliance

Part 15 FCC Rules

This device is compliant with Part 15 of the FCC Rules. Operation is subject to the following two conditions:

1. This device may not cause harmful interference, and
2. This device must accept any interferences received, including interference that may cause undesired operation.

Class B Digital Device or Peripheral

Note: This equipment is tested and complies with the limits for a Class B digital device, pursuant to Part 15 of the FCC Rules. These limits are designed to provide reasonable protection against harmful interference in a residential installation. This equipment generates, uses, and can radiate radio frequency energy and, if not installed and used in accordance with the instructions, may cause harmful interference to radio communications. However, there is no guarantee that interference will not occur in a particular installation. If this equipment does cause harmful interference to radio or television reception, which can be determined by turning the equipment off and on, the user is encouraged to try to correct the interference by one or more of the following measures:

1. Reorient or relocate the receiving antenna.
2. Increase the separation between the equipment and receiver.
3. Connect the equipment into an outlet on a circuit different from that to which the receiver is connected.
4. Consult the dealer or an experience radio/TV technician for help.

Modifications

In accordance with Part 15 of the FCC Rules, the user is cautioned that any changes or modifications not expressly approved by Polycom, Inc. could void the user's authority to operate the equipment. This equipment may not be used on a coin service or party line.

Installation Instructions

Installation must be performed in accordance with all relevant national wiring rules.

L'Installation doit être exécutée conformément à tous les règlements nationaux applicable au filage électrique.

When using PoE (Power over Ethernet), the equipment is to be connected only to PoE networks without connections to the outside plant.

Plugs Acts as Disconnect Device

The socket outlet to which this apparatus is connected must be installed near the equipment and must always be readily accessible.

La prise électrique à laquelle l'appareil est branché doit être installée près de l'équipement et doit toujours être facilement accessible.

Industry Canada (IC)

This Class [B] digital apparatus complies with Canadian ICES-003.

Cet appareil numérique de la classe [B] est conforme à la norme NMB-003 du Canada.

Safety and Compliance (continued)

CE and VCCI Mark

This SoundPoint IP 670 SIP is marked with the CE mark. This mark indicates compliance with EC Directives 2006/95/EC and 2004/108/EC. A full copy of the Declaration of Conformity can be obtained from Polycom Ltd., 270 Bath Road, Slough, Berkshire, SL1 4DX, UK.

この装置は、情報処理装置等電波障害自主規制協議会（VCCI）の基準に基づくクラスB情報技術装置です。この装置は、家庭環境で使用することを目的としていますが、この装置がラジオやテレビジョン受信機に近接して使用されると、受信障害を引き起こすことがあります。
取扱説明書に従って正しい取り扱いをして下さい。

WARNING Electrical Safety

To avoid electric shock, do not connect safety extra low voltage (SELV) circuits to teleconference station network (TNV) circuits. LAN ports contain SELV circuit, and WAN ports contain TNV circuits. Some LAN and WAN ports both use RJ-45 connectors. Use caution when connecting cables.

This product is rated 48Vdc, 0.375A. When used with the optional external power supply, the power supply shall be a Listed power supply with a LPS output, rated 48V, min. 0.375A.

Russian Compliance

Ministry of Information Technologies & Communication of the Russian Federation - Declaration of Conformity. DoC # СПД-1985. Expiry 01/04/2011.

Safety and Compliance (continued)

New Zealand Telepermit

Polycom SoundPoint IP670 VoIP Telephone PTC 220/08/063

PTC General Warning

1. The grant of a Telepermit for any item of terminal equipment indicates only that Telecom has accepted that the item complies with minimum conditions for connection to its network. It indicates no endorsement of the product by Telecom, nor does it provide any sort of warranty. Above all, it provides no assurance that any item will work correctly in all respects with another item of Telepermitted equipment of a different make or model, nor does it imply that any product is compatible with all of Telecom's network services.

The Use of IP Networks through the PSTN

2. Internet Protocol (IP) by its nature introduces delay into speech signals as each data packet is formulated and addressed. Telecom Access Standards recommends that suppliers, designers and installers using this technology for calls to or from the PSTN refer to ITU E Model requirements in the design of their networks. The overall aim is to minimise delay, distortion and other transmission impairments, particularly for those calls involving cellular and international networks, which already suffer extensive delay.

The Use of Voice Compression through the PSTN

3. Because of the extensive delay already experienced when calling cellular and international networks, some of which is already caused by their use of voice compression technologies. Telecom Access Standards will only approve G711 voice technology for use on the PSTN. G711 is an 'Instantaneous Speech encoding Technique' whereas G729 and all its variants are considered 'Near Instantaneous' introducing additional delay into the speech signal.

Echo Cancellation

4. Echo cancellers are not normally required in the Telecom PSTN because geographic delays are acceptable where CPE return loss is maintained within Telepermit limits. However, those private networks making use of Voice over IP technology are required to provide echo cancellation for all voice calls. The combined effect of audio / VoIP conversion delay and IP routing delay can cause the echo cancellation time of 64 mS to be required.

Modification of this Polycom SoundPoint IP670 VoIP Telephone for the New Zealand Network

5. All samples of Polycom SoundPoint IP670 VoIP Telephones connected to the Telecom network shall be equipped with the following software batch Rev 3.0.2.0917. Equipped with this software batch the IP telephone is known to comply with the New Zealand speech transmission plan.

Korean Compliance

한국의 모든 SoundPoint IP 670 휴대 전화 출하

사용자 안내문

B 급기기(가정용 정보통신기기)

이 기기는 가정용으로 전자파적합등록을 한 기기로서 주거지역에서는 물론 모든 지역에서 사용할 수 있습니다.

Index

Symbols

key, page down shortcut 1-14

* key, page up shortcut 1-14

A

AC power 1-4

answering calls 3-4, 3-5, 5-6

assembling your phone 1-3

assigning speed dial keys 3-23, 5-6

attended transfer 3-17

B

backlight intensity 2-4

base, attaching 1-6

blind transfer 3-17

block buddies 4-6

buddy lists 4-5

buddy status 4-7

busy lamp field 5-8

C

call lists

missed calls 2-12

placed calls 2-12

received calls 2-12

types of 2-12

calls

ending 3-7

on hold 3-8

Color Expansion Module. *See* SoundPoint IP
Color Expansion Module

conference calls

adding parties 3-13, 3-14, 3-15

ending 3-16

holding parties 3-14

introduction 3-9

managing 3-12

muting parties 3-13

recording 4-11

removing parties 3-14

setting up 3-10

splitting 3-16

consultative transfer 3-17

contact directory 2-13

contact lists. *See* buddy lists

corporate directory 2-16, 2-19

customizing your phone 2-1

D

display contrast 2-3

Do Not Disturb 3-21

down arrow key, Missed Calls shortcut 2-13

E

electronic hookswitch 2-7

ending calls 3-7

F

features

advanced 4-1

basic 3-1

list of 1-9

phone 1-9

SoundPoint IP Color Expansion Module 5-1

forwarding calls 3-19

G

getting started with your phone 1-1

graphic display backgrounds 2-9

H

handset

- answering a call 3-5
- connecting 1-5
- illustration 1-2
- placing a call 3-3

hands-free mode

- answering a call 3-5
- disabled 3-3
- placing a call 3-3

headset

- answering a call 3-6
- connecting 1-5
- electronic hookswitch 2-7
- memory mode 2-6
- placing a call 3-4

headset memory mode 2-6

holding calls 3-8

I

instant messaging 4-3

L

language support 2-8

left arrow key, Received Calls shortcut 2-13

M

managing buddies 4-6

Microsoft Office Live Communications Server 2005 4-5, 4-7

missed call lists 2-12

multiple call appearances 4-1

multiple calls, hold 3-9

multiple keys per line 2-25

multiple lines

- call forwarding 3-19
- Do Not Disturb 3-22
- ring type 2-7
- support for 2-24
- text messaging 4-3
- Voice Mail 3-25

muting microphone 2-11

MyStat 4-5

N

navigation key usage 1-14

network connection, phone 1-3

P

parts list 1-2

phone

- adjusting backlight intensity 2-4
- adjusting display contrast 2-3
- adjusting volume 2-12
- advanced features 4-1
- answering calls 3-4, 3-5, 5-6
- assembling 1-3
- attaching base 1-6
- basic features 3-1
- buddy lists 4-5
- busy lamp field 5-8
- call lists, types of 2-12
- calls, on hold 3-8
- Color Expansion Module 5-1
- conferences calls 3-9
- contact directory 2-13
- customizing 2-1
- Do Not Disturb 3-21
- electronic hookswitch 2-7
- ending calls 3-7
- ending conferences 3-16
- features, list of 1-9
- figure, features 1-9
- first time use 1-14
- forwarding calls 3-19
- getting started 1-1
- handset 1-5
- headset 1-5
- headset memory mode 2-6
- illustration 1-2
- instant messaging 4-3
- language support 2-8
- managing conferences 3-12
- multiple call appearances 4-1
- multiple keys per line 2-25
- muting microphone 2-11
- navigation key usage 1-14
- parts list 1-2
- placing calls 3-2, 5-5
- playing back calls 4-13
- presence 4-5
- recording calls 4-8
- redialing numbers 3-8
- restarting phone 4-17
- ring type 2-7
- setting time and date 2-2
- setting up conferences 3-10
- shared lines 2-25
- speed dial keys, assigning 3-23, 5-6
- splitting conferences 3-16
- text messaging 4-3
- transferring calls 3-17

- troubleshooting 6-1
 - USB device 1-15
 - using multiple lines 2-24
 - voice mail 3-25
- placed call lists 2-12
- placing calls 3-2, 5-5
- playing back calls
 - answering a call 4-16
 - browsing files 4-14
 - how to start 4-15
 - how to stop 4-15
 - introduction 4-13
 - pausing 4-15
 - resuming 4-15
 - when you can 4-13
 - where you can 4-13
- PoE. *See* Power over Ethernet
- power adapter, connecting 1-4
- Power over Ethernet (PoE) 1-4
- power source, phone 1-3
- presence 4-5

R

- received call lists 2-12
- recording calls
 - file format 4-9
 - how to start 4-11
 - how to stop 4-11
 - introduction 4-8
 - pausing 4-12
 - resuming 4-12
- redialing numbers 3-8
- restarting phone 4-17
- right arrow key, Placed Calls shortcut 2-13
- ring type 2-7
- RJ-9 1-6

S

- shared lines 2-25
- silent ring, answering calls 3-5
- SoundPoint IP Color Expansion Module
 - figure, features 5-4
- speakerphone. *See* hands-free mode
- speed dial keys, assigning 3-23, 5-6
- status information 1-14

T

- text messaging 4-3
- time and date 2-2
- transferring calls 3-17

- troubleshooting
 - audio problems 6-8
 - calling problems 6-5
 - controls problems 6-3
 - diagnostics 6-9
 - display problems 6-7
 - power and startup problems 6-2
 - productivity suite 6-8
 - screen and system problems 6-4

U

- up arrow key, Speed Dial Index shortcut 3-23
- USB device 1-15
- using SIP URL for calling 3-3

V

- voice mail 3-25
- volume 2-12

W

- watch buddies 4-6

End-User License Agreement for Polycom® Software

This End-User License Agreement (“Agreement”) is a legal agreement between you (either an individual or a single entity) and Polycom, B.V for the Polycom Software Product licensed by Polycom B.V in Europe, the Middle East, Africa, and Asia Pacific or Polycom, Inc., for the Polycom Software Product licensed by Polycom, Inc. in the rest of the world (collectively, “Polycom”). The Software Product includes the computer software included herewith and may include associated media, printed materials and online or electronic documentation (“Software Product”). By clicking ‘I agree’ or by installing, copying, or otherwise using the Software Product, you agree to be bound by the terms of this Agreement. If you do not agree to the terms of this Agreement, do not install or use the Software Product, and return it to your place of purchase for a full refund.

The Software Product is protected by copyright laws and international copyright treaties, as well as other intellectual property laws and treaties. The Software Product is licensed (not sold) to you, and its use is subject to the terms of this Agreement.

1. GRANT OF LICENSE.

Subject to the terms of this Agreement, Polycom grants to you a nonexclusive license to install and use the Software Product included with the Polycom product that incorporates or uses the Software Product (the “Product”). You may use the Software Product only in connection with the use of the Product. You are not permitted to lease, rent, distribute or sublicense the Software Product or to use the Software Product in a time-sharing arrangement or in any other unauthorized manner. Further, no license is granted to you in the human readable code of the Software Product (source code). Except as provided below, this License Agreement does not grant you any rights to patents, copyrights, trade secrets, trademarks, or any other rights in respect to the Software Product.

2. DESCRIPTION OF OTHER RIGHTS AND LIMITATIONS.

2.1 Limitations on Reverse Engineering, Decompilation, and Disassembly. You may not reverse engineer, decompile, or disassemble the Software Product, except and only to the extent that such activity is expressly permitted by applicable law notwithstanding this limitation. The Software Product is licensed as a single product. Its component parts may not be separated for use on more than one Product.

2.2 Backup. Except as expressly provided for under this Agreement, you may not copy the Software Product, except, however, you may keep one copy of the Software Product and, if applicable, one copy of any previous version for back-up purposes, only to be used in the event of failure of the original. All copies of the Software Product must be marked with the proprietary notices provided on the original Software Product. You may not reproduce the supporting documentation accompanying the Software Product.

2.3 Modifications. You may not modify, translate, or create derivative works of the Software Product.

2.4 Proprietary Notices. You may not remove or obscure any proprietary notices on or in the Software Product or the supporting documentation.

2.5 Software Transfer. You may permanently transfer all of your rights under this Agreement provided you retain no copies, you transfer all of the Software Product (including all component parts, the media, any printed materials, any upgrades, this Agreement, and, if applicable, the Certificate of Authenticity), and any recipient agrees to the terms of this Agreement. If the Software Product is an upgrade, any transfer must include all prior versions of the Software Product. However, if the Software Product is marked “Not for Resale” or “NFR,” you may not resell it or otherwise transfer it for value.

2.6 Copyright. All title and copyrights in and to the Software Product (including, but not limited to, any images, photographs, animations, video, audio, music, text, and “applets” incorporated into the Software Product), the accompanying printed materials, and any copies of the Software Product are owned by Polycom or its suppliers. The Software Product is protected by copyright laws and international treaty provisions. Title, ownership rights, and intellectual property rights in the Software Product shall remain In Polycom or its suppliers. Title and related rights in the content accessed through the Software Product is the property of such content owner and may be protected by applicable law. This Agreement gives you no rights in such content.

2.7 Confidentiality. The Software Product contains valuable proprietary information and trade secrets of Polycom and its suppliers and you shall protect the confidentiality of, and avoid disclosure and unauthorized use of, the Software Product.

2.8 Dual-Media Software. You may receive the Software Product in more than one medium. Regardless of the type or size of medium you receive, you may use only one medium that is appropriate for your single Product. You may not use or install the other medium on another Product.

2.9 Reservation. Polycom reserves all rights in the Software Product not expressly granted to you in this Agreement.

3. SUPPORT SERVICES.

Polycom may provide you with support services related to the Software Product (“Support Services”). Use of Support Services is governed by the Polycom policies and programs described in the Polycom-provided materials. Any supplemental software code provided to you as part of the Support Services is considered part of the Software Product and is subject to the terms and conditions of this Agreement. With respect to technical information you provide to Polycom as part of the Support Services, Polycom may use such information for its business purposes, including for product support and development. Polycom will not utilize such technical information in a form that personally identifies you.

4. TERMINATION.

Without prejudice to any other rights, Polycom may terminate this Agreement if you fail to comply with any of the terms and conditions of this Agreement. In such event, you must destroy all copies of the Software Product and all of its component parts. You may terminate this Agreement at any time by destroying the Software Product and all of its component parts.

5. UPGRADES.

If the Software Product is labeled as an upgrade, you must be properly licensed to use the software identified by Polycom as being eligible for the upgrade in order to use the Software Product. A Software Product labeled as an upgrade replaces and/or supplements the software that formed the basis for your eligibility for the upgrade. You may use the resulting upgraded Software Product only in accordance with the terms of this Agreement. If the Software Product is an upgrade of a component of package of software programs that you licensed as a single product, the Software Product may be used and transferred only as part of that single Software Product package and may not be separated for use on more than one Product.

6. WARRANTY AND WARRANTY EXCLUSIONS.

6.1 Limited Warranty. Polycom warrants that (a) the Software Product will perform substantially in accordance with the accompanying documentation for a period of ninety (90) from the date of receipt by you, and (b) any Support Services provided by Polycom shall be substantially as described in applicable written materials provided to you by Polycom, and Polycom support engineers will make commercially reasonable efforts to solve any problem issues. Polycom does not warrant that your use of the Software Product will be uninterrupted or error free, or that all defects in the Software Product will be corrected. Polycom’s sole obligation under this express warranty shall be, at Polycom’s option and expense, to

refund the purchase price paid by you for any defective software product which is returned to Polycom with a copy of your receipt, or to replace any defective media with software which substantially conforms to applicable Polycom published specifications. Any replacement Software Product will be warranted for the remainder of the original warranty period or thirty (30) days, whichever is longer.

6.2 Warranties Exclusive. If this Software Product does not operate as warranted above, your sole remedy for breach of that warranty shall be repair, replacement, or refund of the purchase price paid, at Polycom's option. TO THE FULL EXTENT ALLOWED BY LAW, THE FOREGOING WARRANTIES AND REMEDIES ARE EXCLUSIVE AND ARE IN LIEU OF ALL OTHER WARRANTIES, TERMS OR CONDITIONS, EXPRESS OR IMPLIED, EITHER IN FACT OR BY OPERATION OF LAW, STATUTORY OR OTHERWISE, INCLUDING WARRANTIES, TERMS OR CONDITIONS OF MERCHANTABILITY, FITNESS FOR A PARTICULAR PURPOSE, SATISFACTORY QUALITY, CORRESPONDENCE WITH DESCRIPTION, AND NON-INFRINGEMENT, ALL OF WHICH ARE EXPRESSLY DISCLAIMED. POLYCOM NEITHER ASSUMES NOR AUTHORIZES ANY OTHER PERSON TO ASSUME FOR IT ANY OTHER LIABILITY IN CONNECTION WITH THE SALE, INSTALLATION, MAINTENANCE, OR USE OF THIS SOFTWARE PRODUCT.

POLYCOM SHALL NOT BE LIABLE UNDER THIS WARRANTY IF ITS TESTING AND EXAMINATION DISCLOSE THAT THE ALLEGED DEFECT OR MALFUNCTION IN THE SOFTWARE PRODUCT DOES NOT EXIST OR WAS CAUSED BY YOUR OR ANY THIRD PERSON'S MISUSE, NEGLIGENCE, IMPROPER INSTALLATION OR TESTING, UNAUTHORIZED ATTEMPTS TO MODIFY THE PRODUCT, OR ANY OTHER CAUSE BEYOND THE RANGE OF THE INTENDED USE, OR BY ACCIDENT, FIRE, LIGHTNING, POWER CUTS OR OUTAGES, OTHER HAZARDS, OR ACTS OF GOD.

7. LIMITATION OF LIABILITY.

TO THE MAXIMUM EXTENT PERMITTED BY APPLICABLE LAW, IN NO EVENT SHALL POLYCOM OR ITS SUPPLIERS BE LIABLE FOR ANY SPECIAL, INCIDENTAL, INDIRECT, OR CONSEQUENTIAL DAMAGES WHATSOEVER (INCLUDING, WITHOUT LIMITATION, DAMAGES FOR LOSS OF BUSINESS PROFITS, BUSINESS INTERRUPTION, LOSS OF BUSINESS INFORMATION, OR ANY OTHER PECUNIARY LOSS) ARISING OUT OF THE USE OR INABILITY TO USE THE SOFTWARE PRODUCT OR THE PROVISION OF OR FAILURE TO PROVIDE SUPPORT SERVICES, EVEN IF POLYCOM HAS BEEN ADVISED OF THE POSSIBILITY OF SUCH DAMAGES. IN ANY CASE, POLYCOM'S ENTIRE LIABILITY SHALL BE LIMITED TO THE GREATER OF THE AMOUNT ACTUALLY PAID BY YOU FOR THE SOFTWARE PRODUCT OR U.S. \$5.00; PROVIDED, HOWEVER, IF YOU HAVE ENTERED INTO A POLYCOM SUPPORT SERVICES AGREEMENT, POLYCOM'S ENTIRE LIABILITY REGARDING SUPPORT SERVICES SHALL BE GOVERNED BY THE TERMS OF THAT AGREEMENT.

8. DISCLAIMER.

Some countries, states, or provinces do not allow the exclusion or limitation of implied warranties or the limitation of incidental or consequential damages for certain products supplied to consumers, or the limitation of liability for personal injury, so the above limitations and exclusions may be limited in their application to you. When the implied warranties are not allowed to be excluded in their entirety, they will be limited to the duration of the applicable written warranty. This warranty gives you specific legal rights which may vary depending on local law.

9. EXPORT CONTROLS.

The Software Product may not be downloaded or otherwise exported or re-exported (i) into (or to a national or resident of) Cuba, North Korea, Iran, Syria, Sudan, or any other country to which the U.S. has embargoed goods; or (ii) to anyone on the U.S. Treasury Department's List of Specially Designated Nationals or the U.S. Commerce Department's Table of Denial Orders. By downloading or using this Software Product, you are agreeing to the foregoing and you are representing and warranting that you are

not located in, under the control of, or a national or resident of any such country or on any such list. If you obtained this Software Product outside of the United States, you are also agreeing that you will not export or re-export it in violation of the laws of the country in which it was obtained.

10. MISCELLANEOUS.

10.1 Governing Law. This Agreement shall be governed by the laws of the State of California, as such laws are applied to agreements entered into and to be performed entirely within California between California residents, and by the laws of the United States. The United Nations Convention on Contracts for the International Sale of Goods (1980) is hereby excluded in its entirety from application to this Agreement.

10.2 General. This Agreement represents the complete agreement concerning this license and may amended only by a writing executed by both parties. If any provision of this Agreement is held to be unenforceable, such provision shall be reformed only to the extent necessary to make it enforceable.

10.3 Contact. If you have any questions concerning this Agreement, or if you desire to contact Polycom for any reason, please contact the Polycom office serving your country.

10.4 U.S. Government Restricted Rights. The software and documentation provided by Polycom pursuant to this Agreement are "Commercial Items," as the term is defined at 48 C.F.R. §2.101, consisting of "Commercial Computer Software" and "Commercial Computer Software Documentation," as such terms are used in 48 C.F.R. §12.212 or 48 C.F.R. §227.7202, as applicable. Consistent with 48 C.F.R. §12.212 or 48 C.F.R. §§227.7202-1 through 227.7202-4, as applicable, the Commercial Computer Software and Commercial Computer Software Documentation are licensed to United States Government end users (1) only as Commercial Items and (2) with only those rights as are granted to all other users pursuant to the terms of this Agreement.

www.polycom.com

Corporate Headquarters: 4750 Willow Road, Pleasanton, CA 94588,
USA
Phone: 925.924.6000

Israel Office: 94 Derech Em Hamoshavot P.O.B. 3654,
Petach-Tikva 49130, Israel
Phone: +972 3 925 1444
Fax: +972 3 921 1571

Netherlands Office: Tarnspolis Park, Siriusdreef 41, 2132 Wt
Hoofddorp Netherlands
Phone: 31-0-230-2600